

NOTE: If the fuse panel on your 510372 66-68 Impala kit **HAS** a sticker like the photo at the left, you have the second design harness and your instructions are listed below and follow this page.

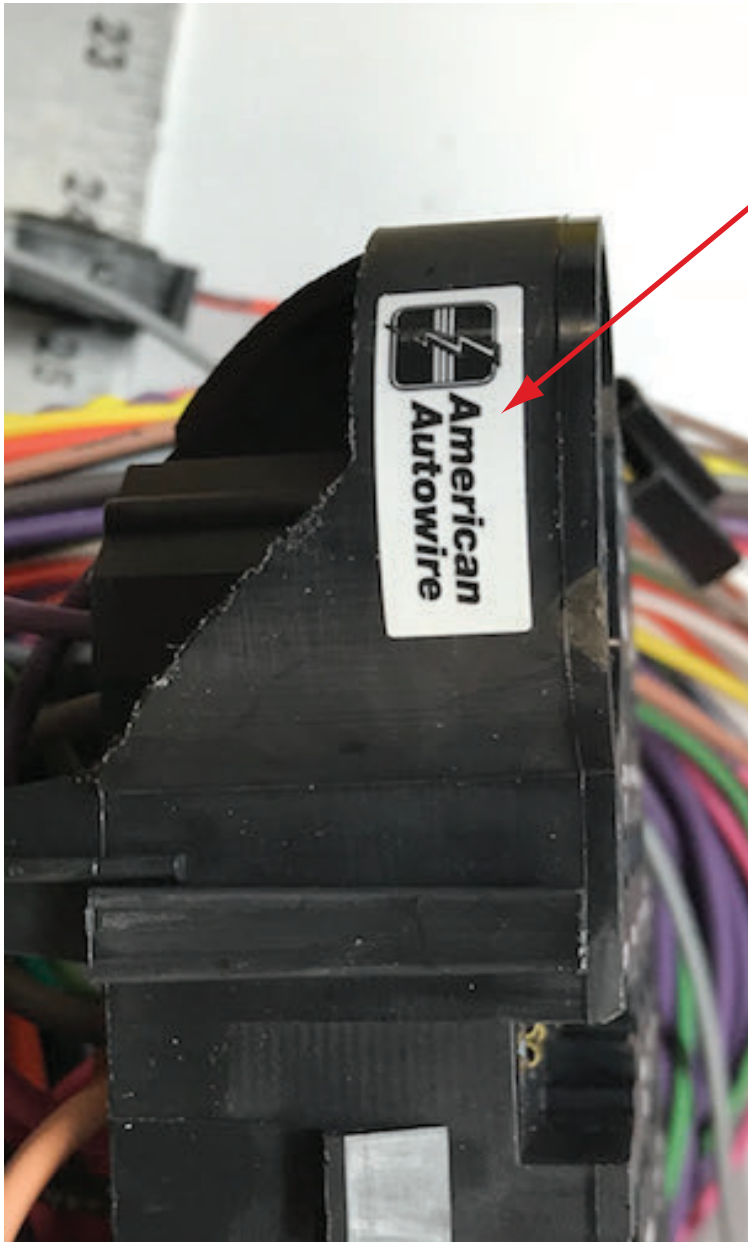

Number	Description
500332	Headlight Switch
500707	Fuse, Relay, and Flasher kit
500708	Courtesy Light kit
500684	Ignition Switch
500919	Practice Terminal Crimping Set
510537	Dash Harness kit
510538	Engine Wiring kit
510539	Front Light Wiring kit
510741	Instrument Cluster Wiring kit
510365	Rear Body Wiring kit
510366	Console Wiring kit
510476	Alternator and main power Connection kit
510730	VSS Connection kit
500042	Floor Dimmer Switch
92970304	Firewall Mod. Template Sheet
92972587	Kit Introduction Instruction Sheet
92972588	Warning Sheet



**American
Autowire**

www.americanautowire.com 856-933-0801

66-68 Impala
Second Design
Instructions

92972924 rev. 0.0 3/10/2020



WARNING:

Validate the kit contents with the component list included on page 2 of this sheet before proceeding. This kit is intended to be used in a modified vehicle. Please read this sheet thoroughly and be sure that you understand everything explained on it prior to opening any of the enclosed packages, or before attempting to install any of the components. Once this kit has been opened or a component installed, the kit is not returnable.

1. This new upgraded AAW wiring system should typically be used in a **MODIFIED** application only. **For all 1968 applications, you will need to re-use your original ignition switch**, as it is a unique switch that utilizes very different mounting spacer at the dash that will not allow it to work well with the new AAW 500684 switch.
2. This kit supports the use of aftermarket A/C systems and factory heater-only climate control systems. For vehicles equipped with FACTORY A/C, American Autowire has harness solutions for each of the model years covered by this kit. See below for details:
For 1966 Cars: In 1966, the factory A/C wiring was part of the engine and dash harnesses and as such, was never serviced as a separate, stand-alone harness. If you wish to use this Classic Update wiring in a 1966 car equipped with a factory A/C system, you will need to purchase the Factory A/C Add-On Kit, part number **510940**. Please follow the instructions included in that add-on kit for both the A/C and heater functions on cars originally equipped with A/C.
For 1967-68 Cars: The A/C systems for 1967-68 cars were separately serviced by stand-alone wiring harnesses. The part numbers are as follows:
CG77588 (**1967, early production w/ separate low blower switch**)
CG70675 (**1967, late production**)
CG85099 (**1968**)
Contact the AAW Sales Team to confirm your application or to place an order.
3. This kit supports the use of a high current self-exciting 1-wire, "SI" series, or other style internally regulated alternator. An adapter may be necessary in some applications. The use of stock, low amperage alternators is seriously discouraged as they cannot handle the higher current requirements of most updated ignition systems, electric fans, aftermarket A/C systems, stereo systems, air ride suspensions, and other power hungry accessories that will ultimately create performance issues within the system.
4. This kit **WILL NOT** support the use of a factory ammeter. All AAW kits are engineered to supply the optimum charge to the battery. To achieve this performance, we route our 6ga. charge wire directly from the alternator output charge terminal to the starter battery terminal. Due to the path of the charge being altered from the stock configuration, the gauge can no longer see a charge vs. a discharge, so it will not work properly. When ammeters were originally used, most generator or alternator current outputs were rated at a maximum of about 25-60 amps. Modified cars being built today typically utilize a 100 amp or higher output alternator. With these higher current units, ammeters, generally speaking, become a safety hazard. Ammeters are usually wired in parallel to the charging circuit, are typically unfused, and can short very easily causing a fire. A voltmeter is recommended as a good alternative.
5. This kit **IS NOT** set up with a resistance wire for a standard, points type ignition system. It is wired with a full 12 volt primary ignition feed that is hot in the crank and run positions. Our system will support HEI, MSD, other electronic ignition systems, as well as most all computerized Fuel Injection systems. If you wish to run a points type system, there are illustrations on the engine connection pages to do so. Primary ignition voltage in the cranking position is handled via a full 12 volt bypass wire that routed from the starter to the coil. Extra parts (ballist resistor) that are not included in this kit will be required to complete that type of operation.



510372

510372 - Classic Update Series Kit 1966-68 Chevrolet Impala

This kit contains the following components:

<u>Bag</u>	<u>Part Number</u>	<u>Description</u>	<u>Quantity</u>
	500042	Floor Dimmer Switch	1
	500332	Headlight Switch	1
	510632	Ignition Switch	1
	500674	Ignition Switch lock cylinder and keys	1
N	500707	Fuse, Relay, and Flasher kit	1
	500708	Courtesy Light kit	1
	500919	Practice Terminal Crimping Set	1
G	510537	Dash Harness kit	1
H	510741	Instrument Cluster wiring kit	1
J	510538	Engine Wiring Kit	1
L	510539	Front Light Wiring kit	1
M	510365	Rear Body Wiring kit	1
	510366	Console Wiring kit	1
V	510730	VSS Connection Kit	1
Z	510476	Alternator and Main Power Connection kit	1
	92972587	Kit Supplemental Instruction Sheet	1
	92972588	Warning Sheet	1
	92970304	Firewall Modification Template	1

Validate the kit contents with this component list. If there are any discrepancies with incorrect or missing parts, stop your installation and notify the supplier you purchased the kit from before proceeding.



www.americanautowire.com 856-933-0801

510372

Classic Update Series

1966-1968 Impala

START HERE !

PLEASE READ THIS BEFORE STARTING INSTALLATION !

This wiring kit is designed for ease of installation. Please read the guidelines below, BEFORE STARTING your installation to guarantee a successful job. Use an appropriate crimping tool which folds the wings of the open barrel terminals down into the wire as shown below. ALL TERMINALS THAT YOU INSTALL SHOULD BE PROPERLY SOLDERED. Our factory crimped terminations are installed by GM approved five ton presses, and soldering these terminations is not necessary. AAW offers a great terminal crimping video entitled "Proper Crimping Video". It can be viewed by visting YouTube. Type the following address into your web browser to go directly to the video: www.youtube.com/watch?v=8u_EkMsiomy.



AS THIS HARNESS IS DESIGNED FOR USE IN A MODIFIED CAR REQUIRING A HIGHER RATE OF CHARGE, IT DOES NOT SUPPORT THE USE OF A STOCK (ORIGINAL) EXTERNALLY REGULATED ALTERNATOR. IT IS DESIGNED FOR USE WITH AN INTERNALLY REGULATED "SI" OR SINGLE WIRE STYLE ALTERNATOR. IT CAN ALSO BE USED WITH THE LATER "CS" AND "CS-D" UNITS BY USING ALTERNATOR ADAPTERS WHICH ARE SOLD SEPARATELY. CONTACT AAW OR YOUR FAVORITE DEALER FOR THE PROPER ALTERNATOR ADAPTER FOR YOUR CAR.

STEP 1: DISCONNECT YOUR BATTERY:

Disconnect the battery before installing the wiring kit to prevent any accidental shorting caused by loose bare wire ends.

STEP 2: START INSTALLING KIT:

This kit is broken down into individual steps that are identified by a letter printed on the instruction sheets visible through each bag. These letters are the order of operation for installaing your kit. Start with bag letter G, then H, etc.

The order of installation is shown below:

- G 510537 Dash Harness Kit
- H 510741 Instrument Cluster Kit
- J 510538 Engine Kit
- L 510539 Front Light Kit
- M 510365 Rear Body Kit
- 510366 Console Connection Kit
- N 500708 Courtesy Light Kit
- V 510730 VSS Connection Kit
- Z 510476 Alternator and Main Connection Kit

STEP 3: RECONNECT YOUR BATTERY:

When you have completed the installation and are ready to reconnect the battery, make sure that the following electrical system grounds are in place:

- A. Battery is grounded to the ENGINE BLOCK.
- B. Battery is grounded to the frame.
- C. Engine block is grounded to the frame.
- D. Body is grounded to the frame.

STEP 4: CHECK ALL ELECTRICAL FUNCTIONS:

Any non-functioning items should be checked for proper installation. Any problems with your wiring and electrical circuit functions should be addressed to American Autowire Systems, Inc. as soon as possible to avoid any warranty problems.

If you have any questions concerning this or any of our products, please feel free to call us at 1-856-933-0801.

AMERICAN AUTOWIRE MAKES IT EASY!

We carry many accessories for your 1965 Impala

p/n R0067108
OEM style non-stick harness tape



p/n 510585
OEM small terminal crimping tool (16-8 gauge)

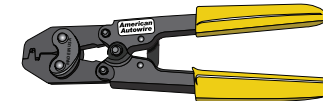

p/n 510586
OEM large terminal and double terminal crimping tool (16-8 gauge)

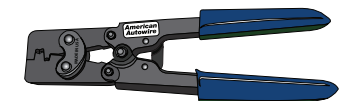

Muncie 4 speed back up lamp switch.
p/n 01993307 (1966-67)
p/n 01993431 (1968)



p/n 36325 (1966)
p/n 36326 (1967)
p/n 36327 (1968)
Factory assembly manual. (It's what they used on the assembly line to build your Impala!)

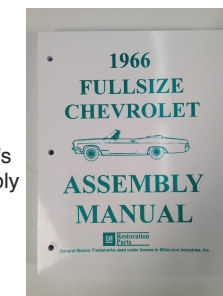

OEM style wiper switch.
p/n 01993678 (1966) 2 spd w/washer
p/n 01993680 (1966) 1 spd w/washer
p/n 01993442 (1968) w/ depressed park

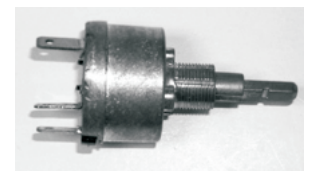

p/n 38131
Breakerless Ignition Module,
GM V-8 POINT CONVERSION KIT



Factory A/C Wiring:
p/n 510940 (1966)
p/n CG70675 (1967)
p/n CG77588 (1967 w/ separate low blower)
p/n CG85099 (1968)

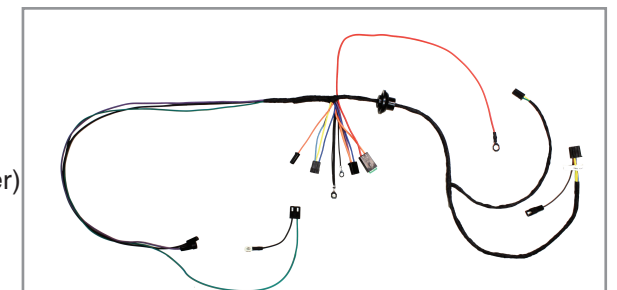

American Autowire

www.americanautowire.com 856-933-0801

Classic Update Series

1966-1968 Impala

510372

© COPYRIGHT 2004 American Autowire / Factory-Fit
Used with express permission of
American Autowire / Factory-Fit
92972587 instruction sheet rev. 1.0 JDM 07/17/2023

Classic Update Series

1966-1968 Impala



www.americanautowire.com 856-933-0801

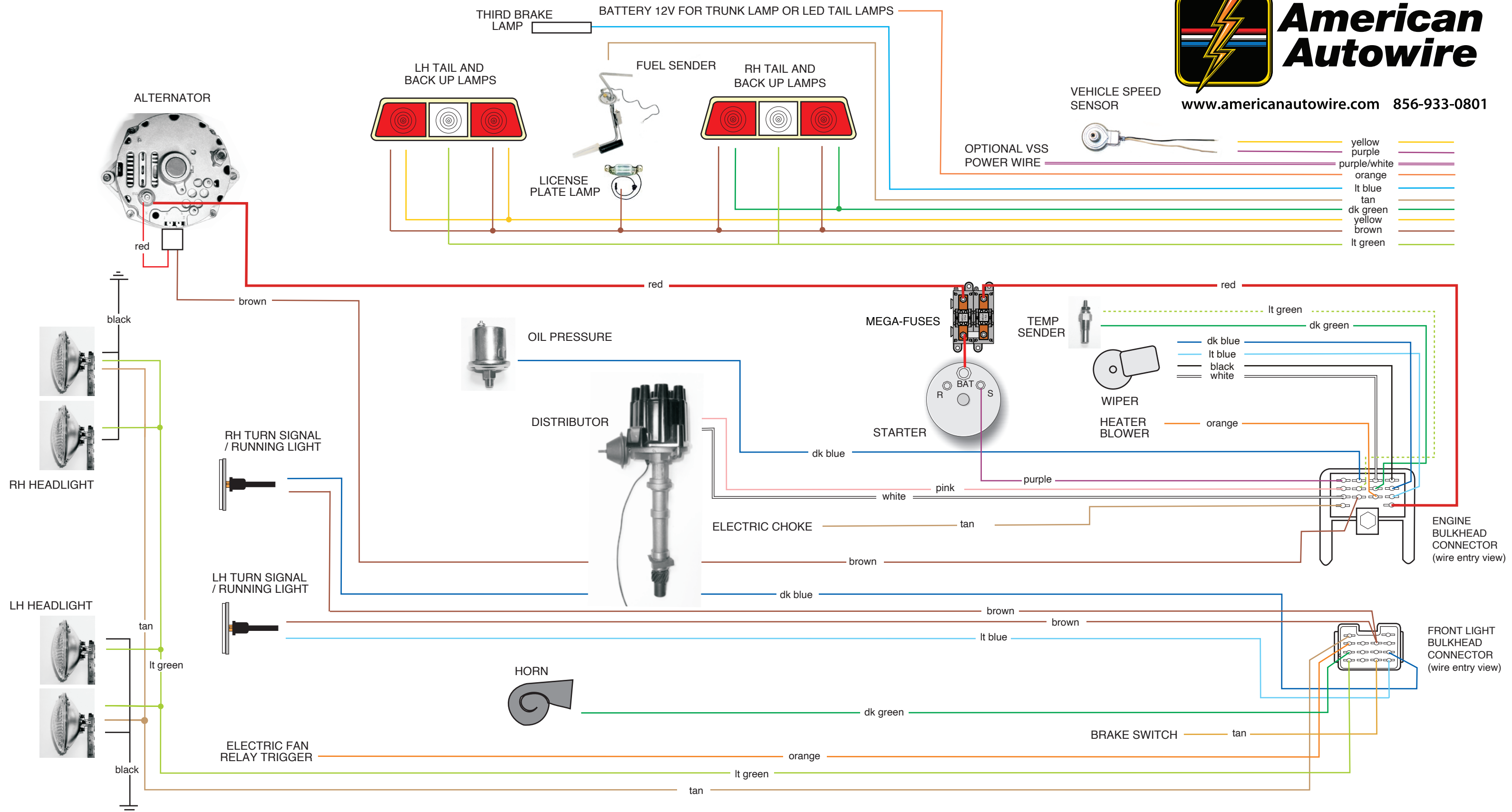

NOTICE: This schematic drawing is for reference only. Do not use the schematic to install this wiring kit! Use the instruction sheets included in each bag, which includes directions for proper terminations, connector indexing, and specific applications.

510372

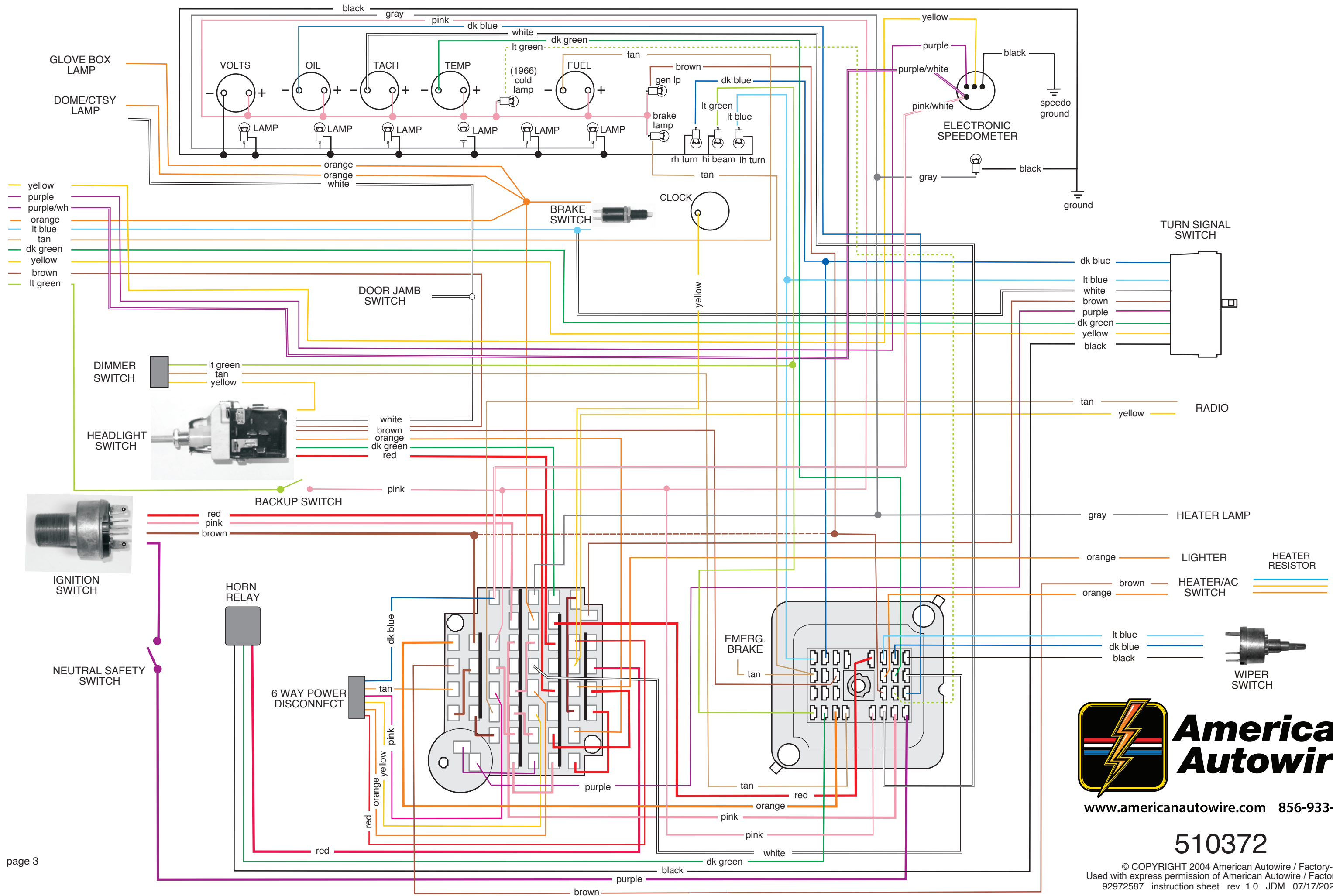

**American
Autowire**

www.americanautowire.com 856-933-0801

510372

© COPYRIGHT 2004 American Autowire / Factory-Fit
Used with express permission of American Autowire / Factory-Fit
92972587 instruction sheet rev. 1.0 JDM 07/17/2023

THIS PAGE HAS INTENTIONALLY BEEN LEFT BLANK



**American
Autowire**

www.americanautowire.com 856-933-0801

Classic Update
Series

1966-1968 Impala

510372

© COPYRIGHT 2004 American Autowire / Factory-Fit
Used with express permission of
American Autowire / Factory-Fit
92972587 instruction sheet rev. 1.0 JDM 07/17/2023

1965 thru 1967 Impala Classic Update Kit firewall modification template

This Classic Update Series kit is based on the 1968 and later GM bulkhead assembly which has a different mounting footprint than the earlier 1965 - 67 bulkhead connectors. Therefore, it will be necessary to modify the firewall of the 1965 - 67 Chevy Fullsize cars to accept the 1968 and later design bulkhead. This template will be used for that purpose.

The white area should be cut out with a razor knife to define the area of material that needs to be removed from the existing bulkhead area. We suggest that this template be glued to stiff cardboard or a thin piece of plastic or be applied directly to the cleaned firewall on the inside of the car then proceed as follows:

1. Position the template against the firewall aligning the top, bottom, and left hand edges of the template with the top, bottom, and left hand edges of the original bulkhead opening hole in the firewall.
2. Trace the opening area onto the existing firewall bulkhead and cut out and remove the necessary material in that opening area.
3. Drill the two 0.125 holes for the new fusebox mounting screws.
4. Mount the fusebox assembly from the passenger compartment side, then check the fit into the new bulkhead firewall opening hole. It may be necessary to do some fine tuning on the hole area with a file for an exact fit.
5. Attach the new fusebox assembly and dash harness to the firewall in the new bulkhead firewall opening using the enclosed fusebox retaining screws to complete the installation.

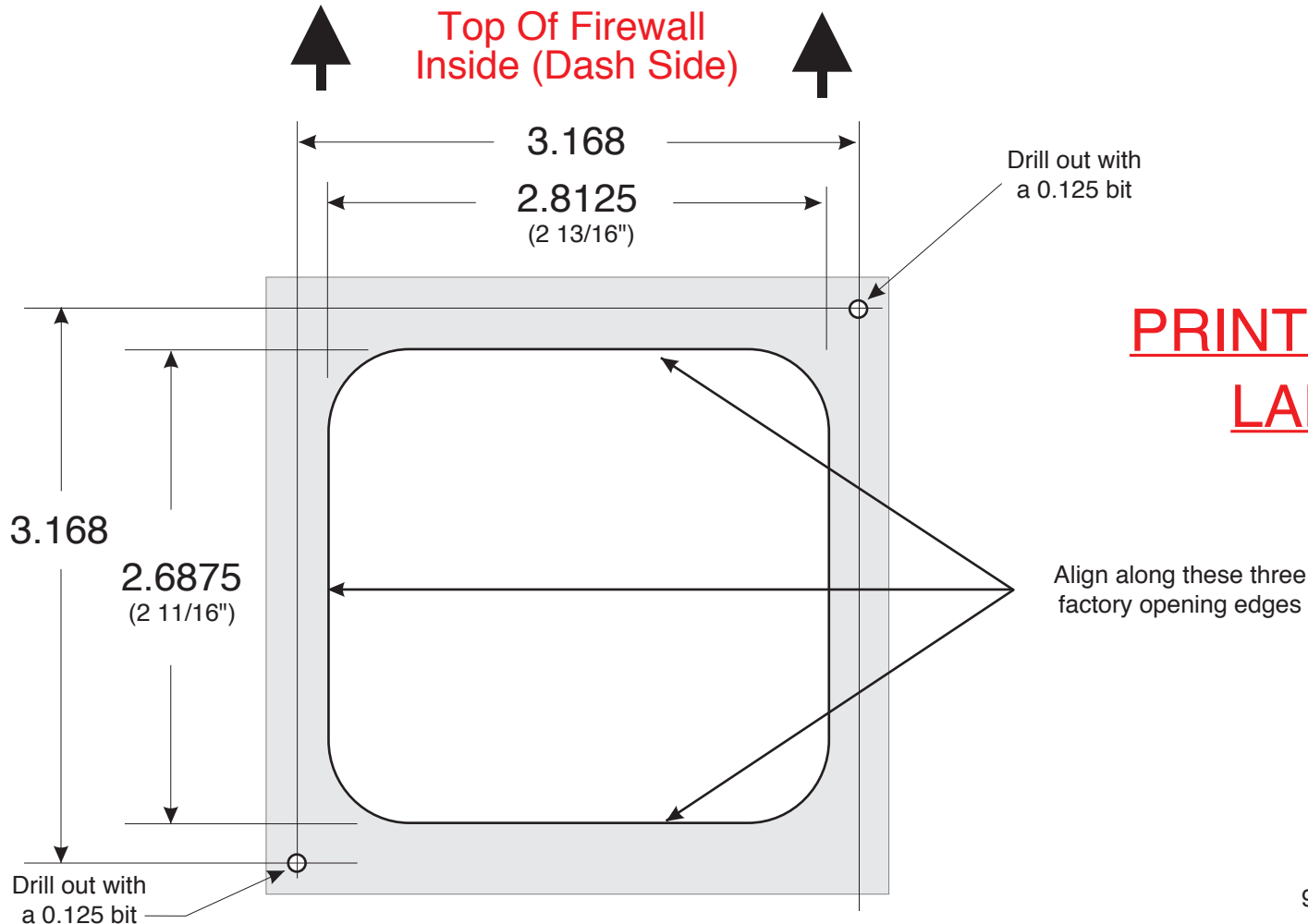

PRINT ON ADHESIVE LABEL SHEET

92970304

92970304 Rev 1.0 4/22/2014

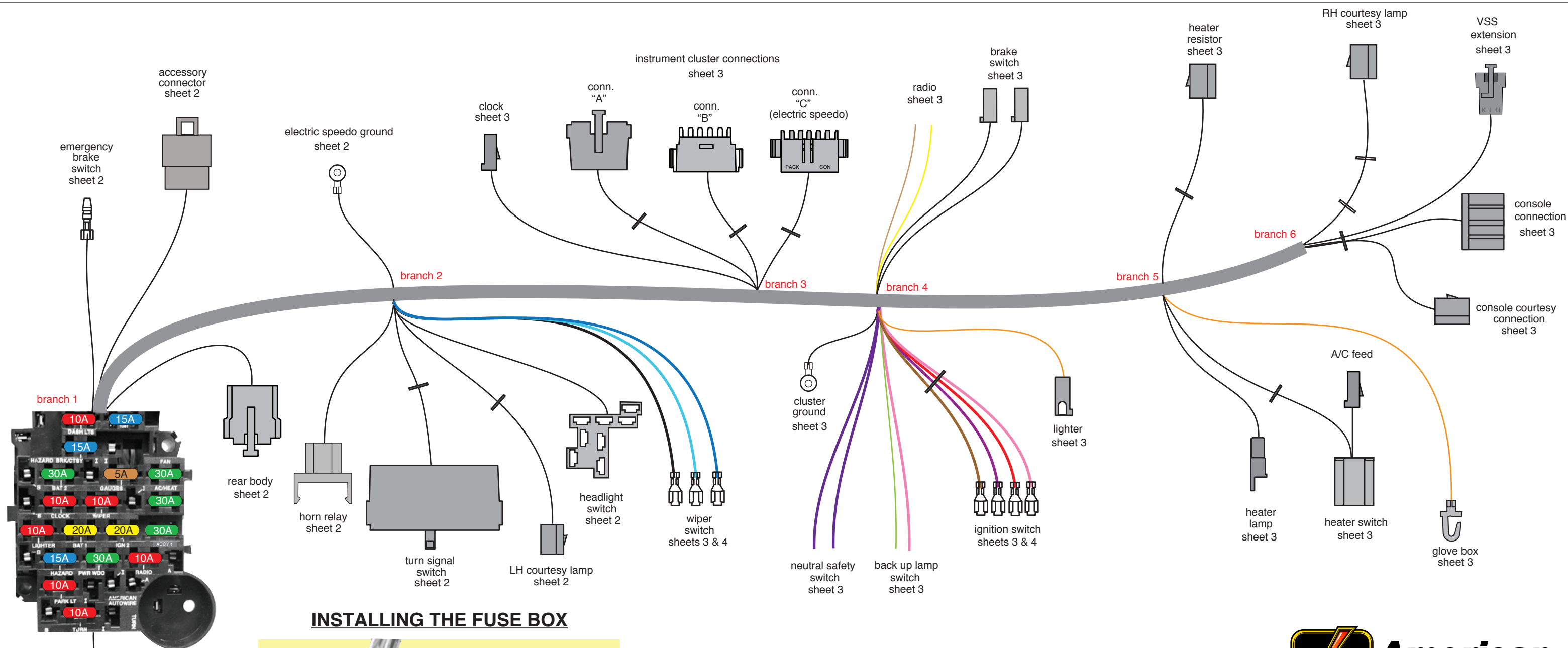

INSTALLING THE FUSE BOX

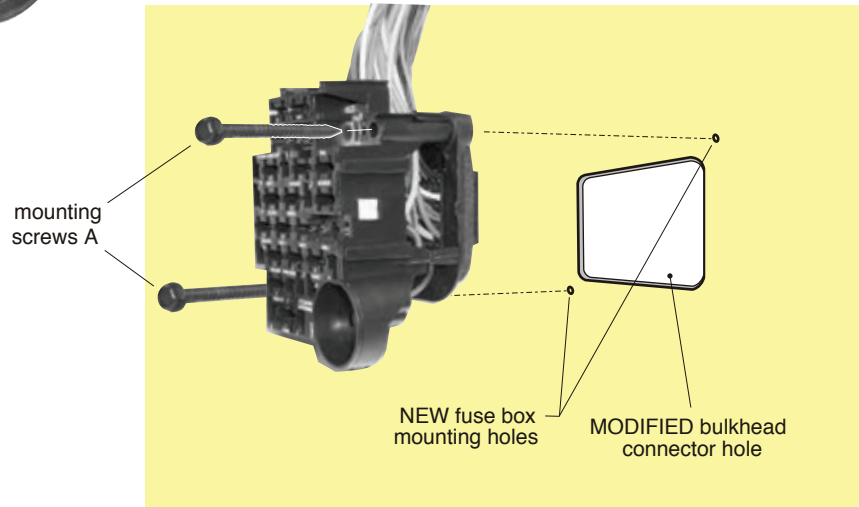

Fuse Panel Installation Instructions

Following these simple instructions will guarantee a successful installation of your American Autowire fuse panel harness.

1. Study the diagram above to familiarize yourself with the dash harness.
2. Modify your firewall opening and install the fuse box .(See item #1 below left, and 92970304 template)
3. Install the fuse box.
4. Route the dash harness using the factory support straps.
5. Make all connections as shown on the following pages of this dash harness kit.
6. Once this harness is installed, continue to bag 'H', and install the rest of the kit (bags H,J,K,L,M).

1. Locate the new bulkhead pass thru hole in the driver side of the firewall. **NOTE: If your car is a 1965-67 model, you will need to modify the opening in the firewall by making it larger. See firewall template 92970304 to help with this operation.**
2. Mount the fuse box with the flasher can in the bottom right corner, as shown above.
3. Using the two mounting screws A, attached the fuse panel to the firewall.



www.americanautowire.com 856-933-0801



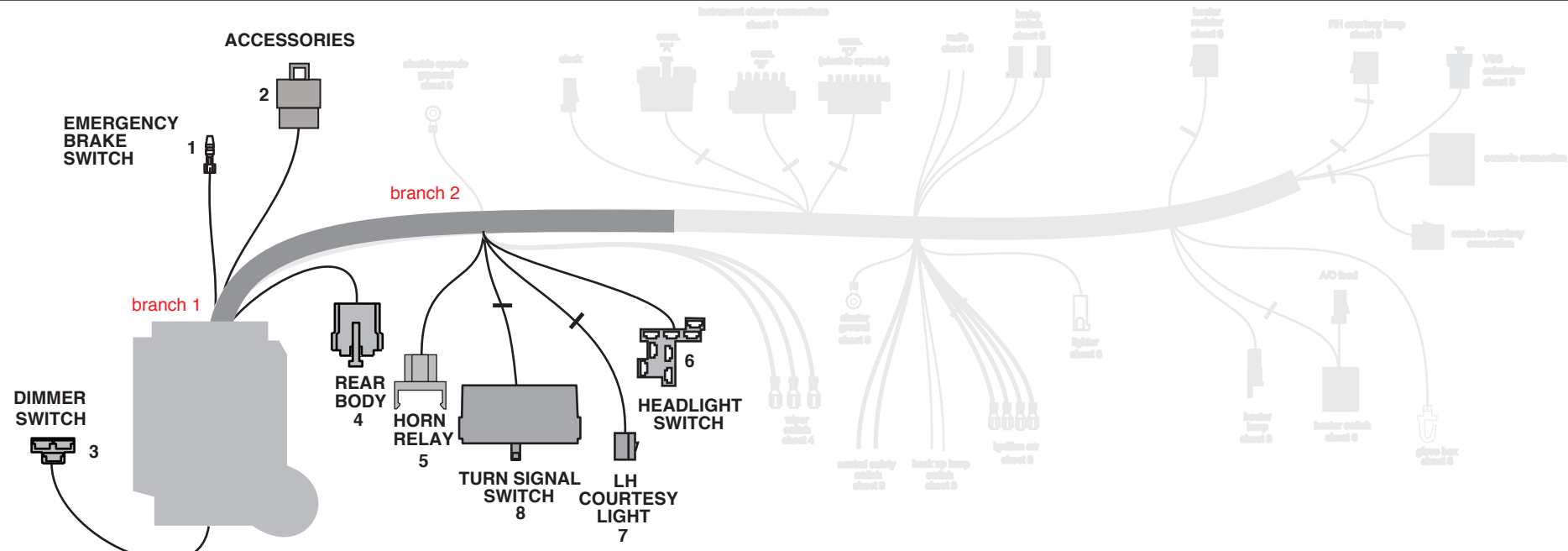

- 1 EMERGENCY BRAKE
- 2 ACCESSORIES
- 3 DIMMER SWITCH
- 4 REAR BODY
- 5 HORN RELAY
- 6 HEADLIGHT SWITCH
- 7 LH COURTESY LAMP
- 8 TURN SIGNAL SWITCH

Tan
Dark Blue
Orange
Red
Pink
Yellow
Tan

Yellow
Light Green
Tan

Tan
Brown
Yellow
Dark Green
Orange
White
Light Green
Light Blue

Red
Black
Dark Green

Red
Orange
Brown
Yellow
Dark Green
White

Orange
White

White
Dark Green
Yellow
Purple
Brown
Dark Blue
Light Blue
Black
Gray

Connect to the emergency brake switch. This is the ground circuit for the brake warning switch lamp.
Switched ground to warning lamp.
Use the provided connector that is plugged into the dash harness along with the loose terminals in the loose piece parts kit to connect power leads for the following:

Fuse	Rating	Description
FUEL	15 amp	Fused 12-volt IGNITION feed for fuel pump (may also be used to feed power to another ignition circuit).
BAT1	20 amp	Fused 12-volt BATTERY feed for power seats (may also be used to feed power to another battery circuit).
BAT2	30 amp	Fused 12-volt BATTERY feed for power door locks (may also be used to feed power to another accessory circuit).
IGN1	20 amp	Fused 12-volt IGNITION feed for cruise control (may also be used to feed power to another ignition circuit).
PWRWDO	30 amp	Fused 12-volt IGNITION feed for power windows (may also be used to feed power to another ignition circuit).
ACCY1	30 amp	Fused 12-volt ACCESSORY feed (may also be used to feed power to an accessory circuit).

This connector will mate to the floor mounted dimmer switch (500042).
12-volt feed into dimmer switch from H/L switch.
12-volt feed out to high beam H/L.
12-volt feed out to low beam H/L.
This connector will mate with the connector from the Rear Body harness 510365, bag M.
Fuel tank sender lead.
Rear running lamp and tag lamp feed.
LH turn / brake feed.
RH turn / brake feed.
Dome / courtesy lamp feed.
Dome / courtesy lamp ground.
Back up lamp feed.
Third brake light.
Plug the horn relay (found in the fuse, relay, and flasher bag, 500707) into this connector.
12-volt battery for relay.
Relay ground circuit (from steering column).
Triggered 12-volts out to horn.
This connection will plug onto the new headlamp switch, 500332.
Battery 12-volt input lead to switch for headlamps.
Battery fused 12-volt input lead to switch for park / tail output and dash lamp input.
Park/tail lamp output.
12-volt output lead to dimmer switch for headlamps.
Dash lamp output to fuse panel
Dome / Courtesy ground.
Plug this connector into the mating LH courtesy lamp assembly from 500708, bag N.
12-volt battery fused feed.
Courtesy lamp switched ground.
The connector on this harness will mate directly to the 3 7/8" turn signal switch used by GM and many other aftermarket steering column manufacturers. If you are using a stock 1965-66 tilt column and turn signal switch, an adapter has been provided for you. Install terminals M onto each wire from the adapter and plug those terminals into connector L as shown above right in "Diagram A". If you are using any other stock 1965-68 column and turn signal switch, cut the original connector off of your steering column turn signal switch and crimp terminals M onto each of those wires, then plug those terminals into connector L as shown above right in "Diagram B". If you are using an aftermarket column that utilizes the 4 1/4" column connection, removed the terminals from that connector or cut the connector off and crimp terminals M onto the wires from your switch, then plug those terminals into connector L maintaining color continuity with the new switch.

White 12-volt feed from brake switch.
Dark Green RH rear stop and turn.
Yellow LH rear stop and turn.
Purple 12-volt ignition feed from turn signal flasher.
Brown 12-volt battery feed from hazard flasher.
Dark Blue RH front turn.
Light Blue LH front turn.
Black Horn relay ground to horn switch.
Gray Illumination for column PRNDL shift indicator (1965-67 only).

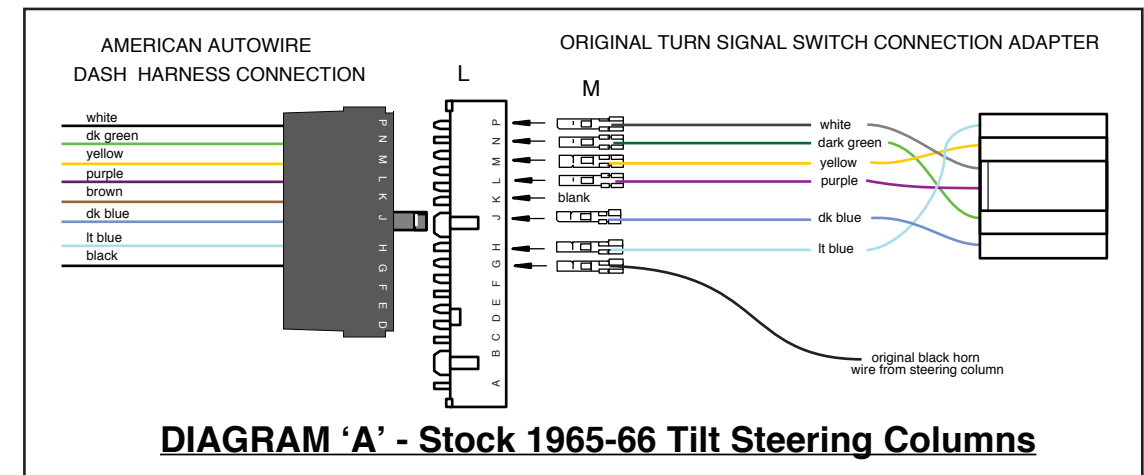

DIAGRAM 'A' - Stock 1965-66 Tilt Steering Columns

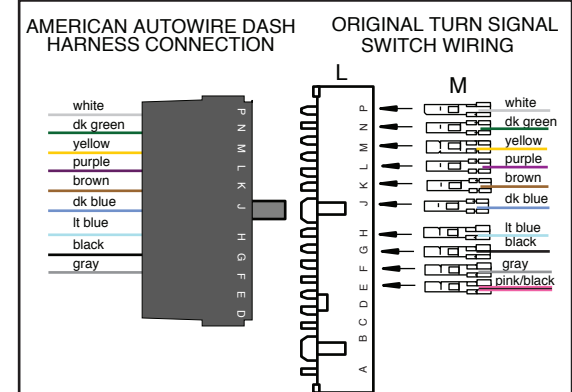
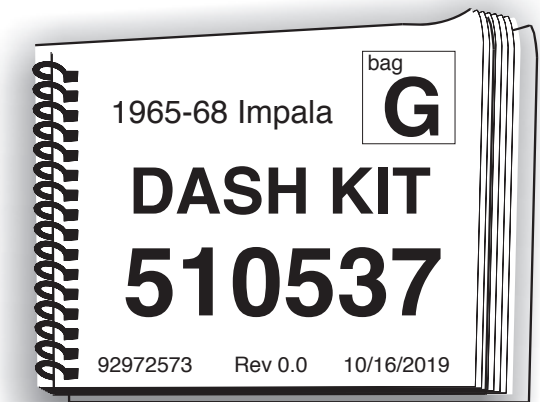
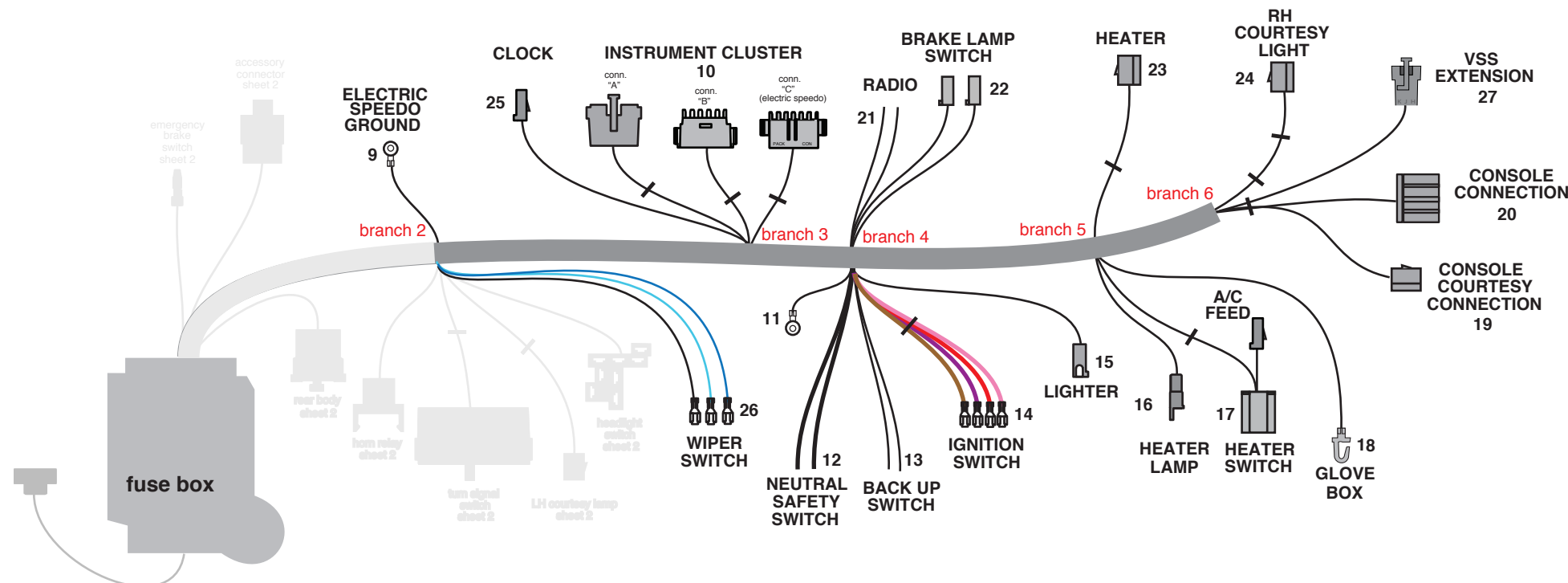

DIAGRAM 'B' - Stock 1965-68 Steering Columns Except 1965-66 With Tilt Column.
NOTE: The brown wire is found on 1967 and 1968 steering columns only! The pink/black wire is found on 1968 columns only and is not used.



www.americanautowire.com 856-933-0801





NOTE: For your information, there were 4 different windshield wiper and washer configurations that Chevrolet used between 1965 and 1968 on all of the different Fullsize models. This new dash kit, 510537, supplies all of the needed connectors (see the loose piece kit inside the 510537 dash harness kit) to handle any of those applications just as your stock dash harness did (see item 26 below on this page). Detailed photos depicting how those connections get plugged in can be found on sheet 4 of this instruction set. Connections to the various different wiper motors that were used can be found in the 510538 engine harness instruction set on sheets 3 and 4.

- | | | | |
|-----|--------------------------------|-------------|---|
| 9 | ELECTRIC SPEEDO GROUND | | Connect to the dash frame, steering column pedal saddle, or any other good known chassis ground. (DO NOT attach this together with item #11 from above. They may be grounded to the same surface or area, just not under the same screw or bolt). |
| 10 | INSTRUMENT CLUSTER DISCONNECTS | Black | Electric speedo ground. |
| 11 | INSTRUMENT CLUSTER GROUND | | These connectors will plug into the Instrument Cluster Harness, 510362 (65) or 510373 (66-68), bag H. Circuit identifications for this branch are described on those instruction sheets. Connect to the dash frame, steering column pedal saddle, or any other good known chassis ground. (DO NOT attach this together with item #9 from above. They may be grounded to the same surface or area, just not under the same screw or bolt). |
| 12 | NEUTRAL SAFETY SWITCH | Black | Cluster and dash lamp grounds. |
| | | Purple | Connect these wires to your neutral safety switch, to the console connection #20 if your car has an automatic console, or together if you are using a manual transmission without an NSS. |
| | | Purple | 12-volt feed in from ignition switch. |
| 13 | BACK UP LAMP SWITCH | | Switched 12-volt feed out to starter solenoid. |
| | | Light Green | Connect these wires to your back up lamp switch or to the console connection #20 (light green only) if your car has an automatic console. |
| | | Pink | 12-volt feed out to back up lamps. |
| 14 | IGNITION SWITCH | | 12-volt ignition feed into back up lamp switch. |
| | | Red | There are two different ignition switch configurations that were used between 1965 and 1968. See sheet 4 for detailed photos depicting the proper connections for the 65 thru 67 and 68 applications. The connectors necessary to complete your particular application can be found in the loose piece kit bag contained in this dash harness, 510537. For the 65 thru 67 applications, this connection will plug onto the new ignition switch, 510632. For the 68 application, you will need to re-use your original ignition switch , as it is a unique switch that utilizes very different mounting adapter that will not work well with the 510632 switch. |
| | | Pink | 12-volt battery feed. |
| | | Brown | 12-volt ignition feed. |
| | | Purple | 12-volt accessory feed. |
| 15 | LIGHTER | Orange | 12-volt starter feed to Neutral Safety Switch. |
| 16 | HEATER CONTROL LAMP | Gray | 12-volt fused battery feed to lighter. |
| 17 | HEATER SWITCH | | Dash lamp feed. |
| | | Brown | Plug this connector onto your stock heater control switch. |
| | | Yellow | 12-volt fused switch feed for heat or A/C power (if using aftermarket A/C, use the short pigtail wire as the switched "ON" "OFF" feed wire to the aftermarket A/C harness.). |
| | | Light Blue | To heater resistor. |
| | | Orange | To heater resistor. |
| 18 | GLOVEBOX LAMP | Orange | To heater resistor and blower motor. |
| 19 | CONSOLE COURTESY CONNECTION | | 12-volt fused battery feed for glovebox lamp. |
| 20 | CONSOLE CONNECTION | | This connector will plug into the console courtesy connection in the Console Extension Harness, 510366. Circuit identifications for this branch are described on those instruction sheets. |
| 21 | RADIO | Tan | This connector will plug into the main console connection in the Console Extension Harness, 510366. Circuit identifications for this branch are described on those instruction sheets. |
| | | Yellow | 12-volt accessory power feed to radio ("ON" and "OFF"). |
| 22 | BRAKE LIGHT SWITCH | | 12-volt fused battery feed for clock and memory. |
| | | Orange | Plug this connector onto your factory stop lamp switch. |
| | | White | 12-volt fused battery feed to stop lamp switch. |
| | | Light Blue | 12-volt out to turn signal switch. |
| 23 | HEATER RESISTOR | | 12-volt out to third brake lamp. |
| 24 | RH COURTESY LAMP | | (Used on stock non A/C equipped cars only) Plug this connector onto the stock heater resistor located on the stock heater box inside the car under the dash. |
| | | Orange | Plug this connector into the mating RH courtesy lamp assembly from 500708, bag N. |
| | | White | 12-volt battery fused feed. |
| | | Yellow | Courtesy lamp switched ground. |
| 25 | CLOCK BATTERY | | Fused 12-volt battery feed for dash mounted clock. |
| 26 | WIPER CONNECTIONS | | There are several wiper switch configurations that were used between 1965 and 1968. See sheet 4 for detailed photos depicting the proper connections for the 65 thru 68 applications. Any connectors necessary to complete your particular application can be found in the loose piece kit bag contained in this dash harness, 510537. |
| | WIPER HI SPEED GROUND | Light Blue | Ground for wiper motor high speed. |
| | WIPER LO SPEED GROUND | Black | Ground for wiper motor low speed. |
| | WIPER - WASHER GROUND | Dark Blue | Ground for washer pump solenoid. |
| 27. | VSS EXTENSION | | These wires are for use with an aftermarket electric speedometer only. The VSS Lead Wires, 510730, bag V, will plug in here. Refer to that instruction sheet for wire functions and additional directions |



www.americanautowire.com 856-933-0801

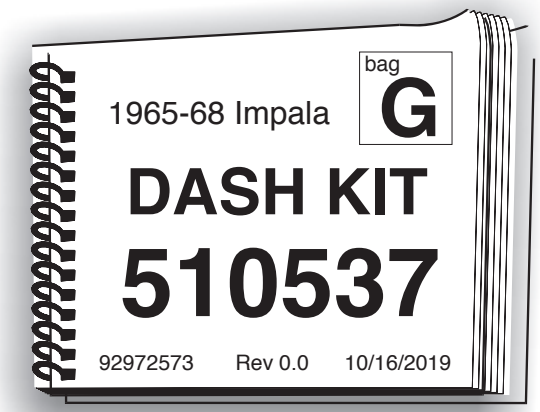

NOTE: On this page, you will find detailed photos depicting how to plug in your ignition switch and wiper switch connector(s). They differ from application to application, and year to year, so please pay close attention, and be sure that you are choosing the proper application for your car.

WINDSHIELD WIPER AND WASHER ASSEMBLY PLUG-INS AND APPLICATIONS



1965 Single Speed without Washer

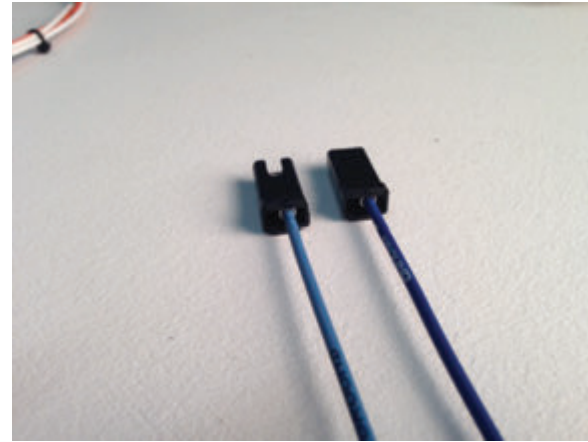

1965 Single Speed with Washer

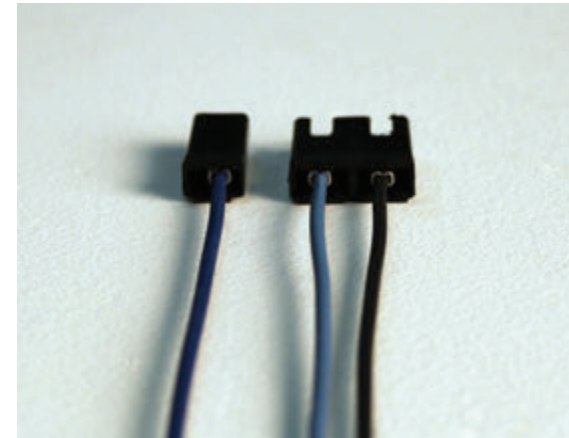

1965-66 Two Speed with Washer

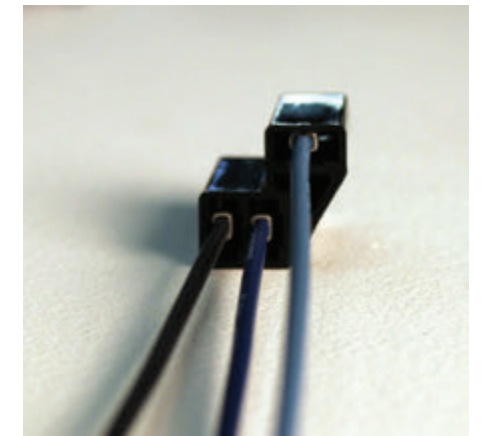

1967-68 Two Speed with Washer

IGNITION SWITCH ASSEMBLY PLUG-INS AND APPLICATIONS

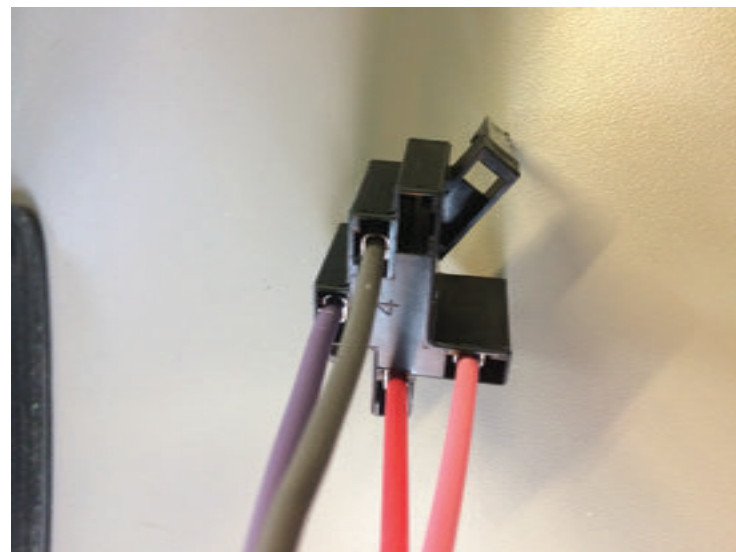

1965-67 Ignition Switch

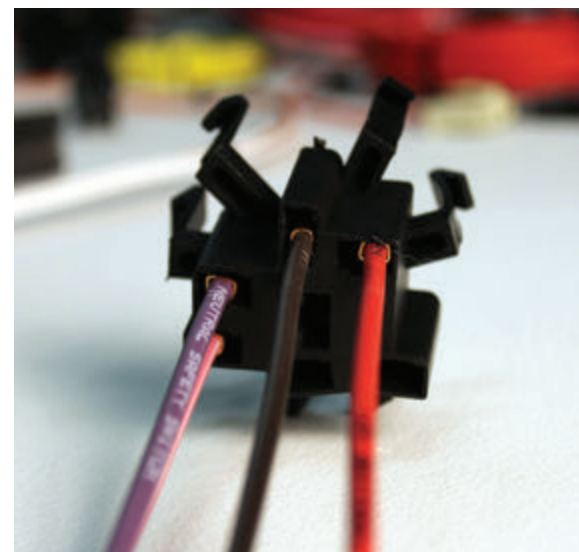

1968 Ignition Switch
(Must re-use your original ignition switch)



www.americanautowire.com 856-933-0801

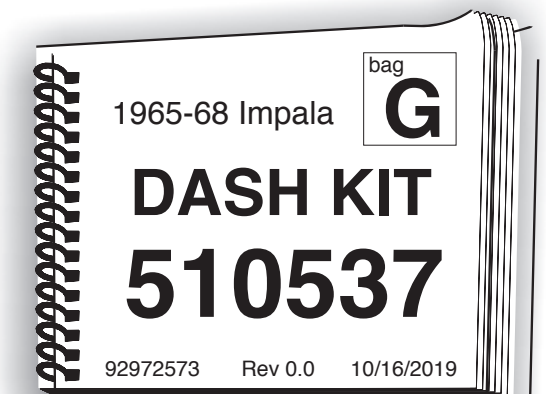

Classic Update Series

*** These are special instructions for connecting your wiring system to a stock instrument cluster. ***

NOTE: If you are using after market gauges, follow the instructions included in the 92965220 Gauge Connection Kit along with the specific gauge manufacturers instructions for connection of their gauges.

If you are using the stock gauges or warning lamps, refer to the diagrams on the following pages for your application. Use the enclosed parts and information below for wire termination, gauge, and lamp connections. Connectors A, B, and C will plug into your dash harness at branch 3 as noted on the Dash Harness instruction (510537, bag G) set. Connection C will only be used in the event that you are using an electric speedometer. **NOTE:** If you have a car with factory gauges, **the ammeter IS NOT supported** in this kit. We suggest the use of a voltmeter as a better way to monitor your charging system.

CONNECTOR A

LT GREEN	(No Printing)	This wire is used on 1966 warning lamp applications only. Plug this loose wire into connector A maintaining color continuity with the mating connector on your dash harness, install terminal A as shown on sheet 2, and plug into the circuit board connector E.
GRAY	Dash Lights	Install terminal A as shown on the following sheets, and plug into the circuit board connector E per your year and application.
BLACK	Ground	Connect to the back of the instrument cluster housing.
PINK	12v ignition	Install terminal A as shown on the following sheets, and plug into the circuit board connector per your year and application.
NOTE: If you have a 1966 car with a factory tach, you will need to double off of the circuit board connector terminal and route the remaining portion of the pink wire over to the hard wired tach as it is not part of the circuit board connection. A wider circuit board terminal B has been provided for you to make this connection possible. In addition, use one of the ring terminals in the 92965220 package to attach the other end of this pink wire to your tach.		

CONNECTOR B

DK GREEN	Water Temp Sender	Install terminal A as shown on the following sheets, and plug into the circuit board connector E per your year and application. NOTE: If your car is a 1966 with console gauges, this wire WILL NOT BE USED . Coil it up or remove it from connector A.
TAN	(Brake Warning Lamp)	Install terminal A as shown on the following sheets, and plug into the circuit board connector E per your year and application.
DK BLUE	Oil Pressure Sender	This wire is used on warning lamp applications only and is stamped "OIL PRESSURE SENDER". Plug this wire into your dash cluster connector as shown on pages 2,4, and 6. This wire is not used for factory gauge cars and must be removed from Connector B as noted on pages 3,5, and 7.
BROWN	Alternator Ign	This wire is used on warning lamp applications only, is stamped "ALT-IGN", and is for your generator lamp. Plug this loose wire into connector B maintaining color continuity with the mating connector on your dash harness, install terminal A as shown on the following sheets, and plug into the circuit board connector E per your year and application.
WHITE	Coil Tach	If your car is equipped with a tach, plug this loose wire into connector B maintaining color continuity with the mating connector on your dash harness, install terminal A as shown on the following sheets, and plug into the circuit board connector E per your year and application (67-68 models). NOTE: If your car is a 1966 model, install terminal C and connector D as shown on sheets 2 and 3, and connect to the male blade on the tachometer.
DK BLUE	Right Turn Indicator	Install terminal A as shown on the following sheets, and plug into the circuit board connector E per your year and application.
LT BLUE	Left Turn Indicator	Install terminal A as shown on the following sheets, and plug into the circuit board connector E per your year and application.
LT GREEN	Hi Beam Indicator	Install terminal A as shown on the following sheets, and plug into the circuit board connector E per your year and application.
TAN	Gas Gauge	Install terminal A as shown on the following sheets, and plug into the circuit board connector E per your year and application.

CONNECTOR C

This connector is used when using an aftermarket electronic speedometer only. Follow the manufacturer's instructions when installing these wires. If you are using the stock speedometer, then discard this connector. See page 8 for wire descriptions and typical connections.

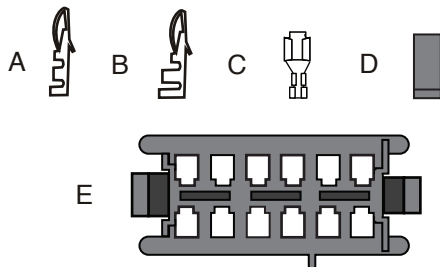

**American
Autowire**

www.americanautowire.com 856-933-0801

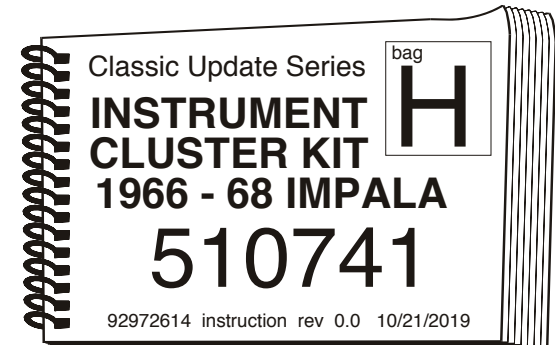

Classic Update Series

1966 CHEVY ALL FULLSIZE W/ WARNING LAMPS CLUSTER CONNECTIONS

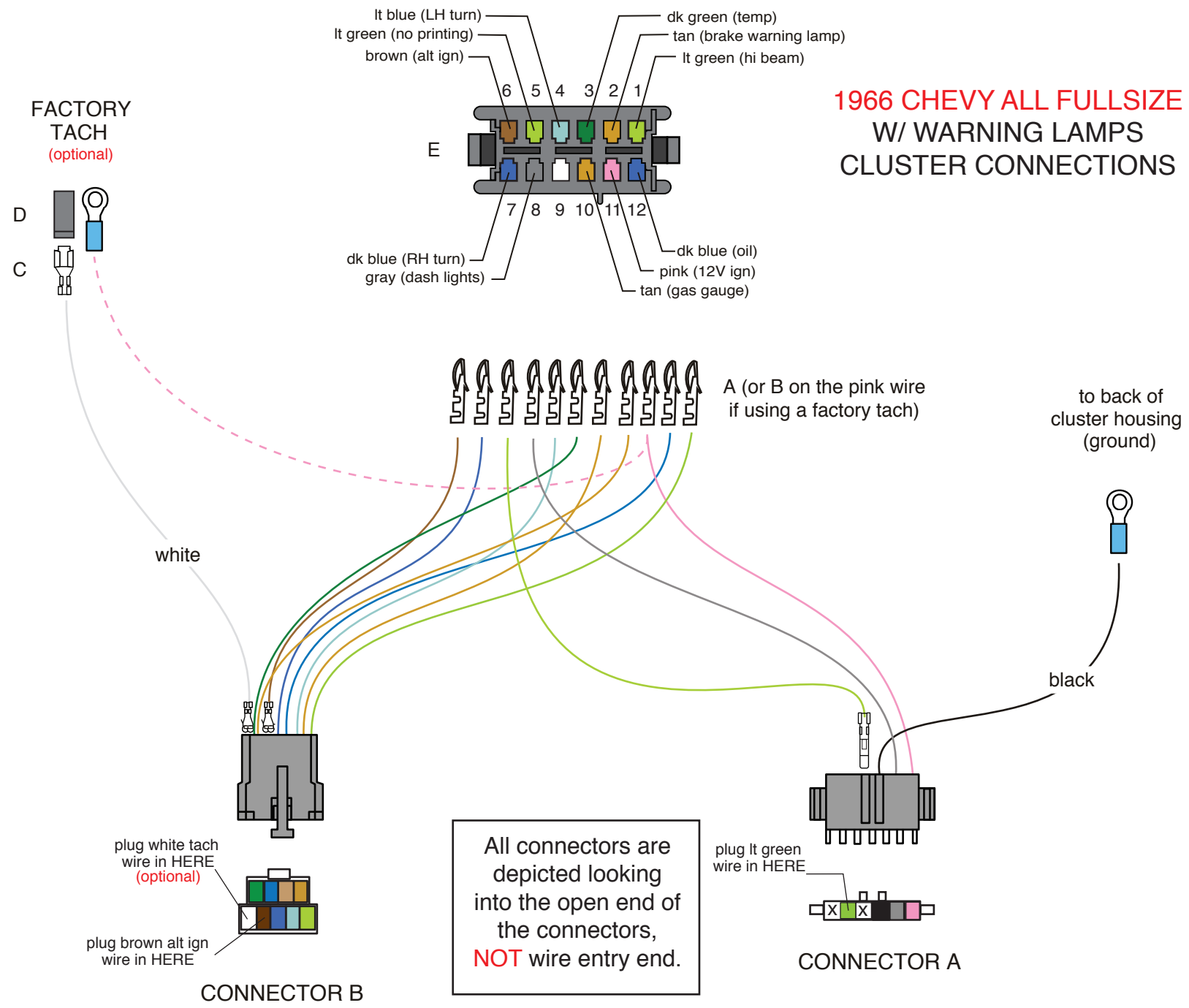

Classic Update Series

FACTORY
TACH
(optional)

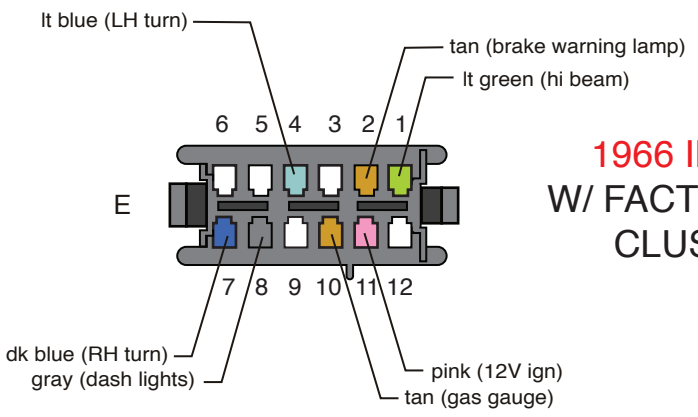
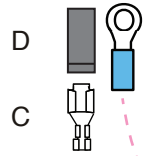

1966 IMPALA SS or CAPRICE W/ FACTORY CONSOLE GAUGES CLUSTER CONNECTIONS

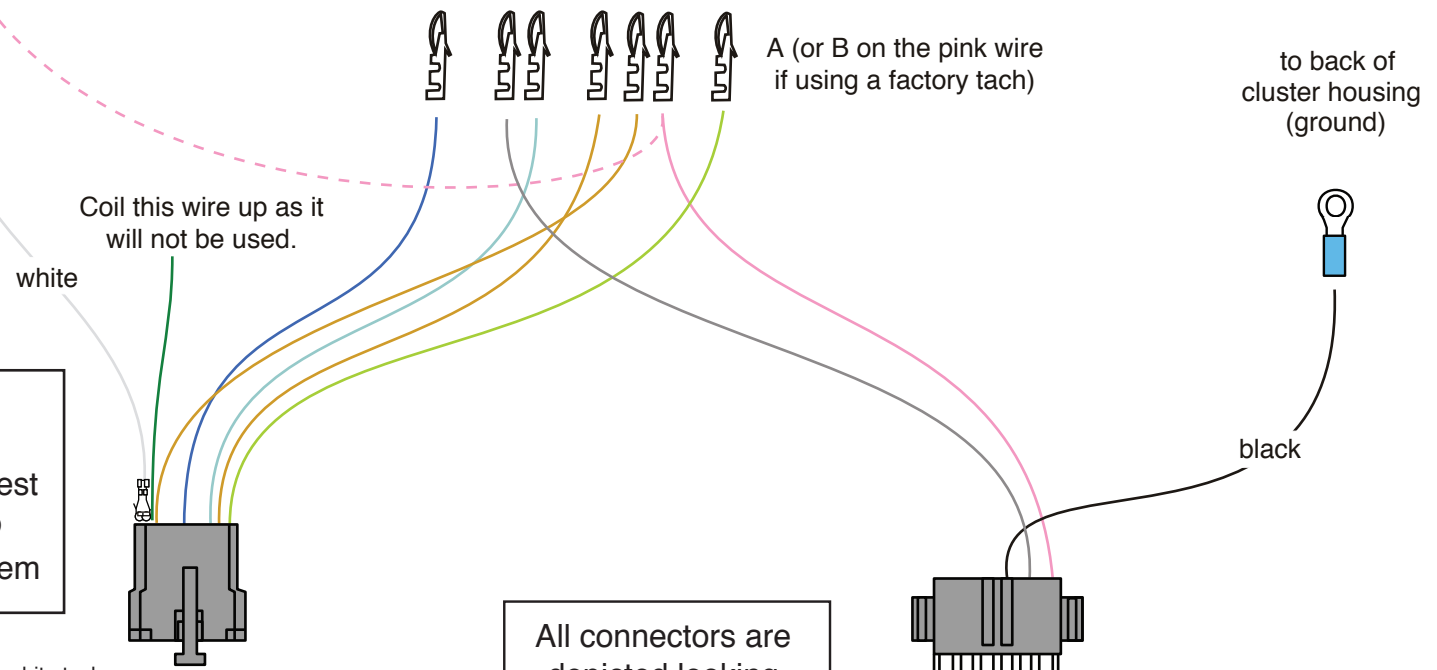

NOTE: This kit does not support the use of the factory ammeter. We suggest the use of a voltmeter to monitor your charging system

All connectors are depicted looking into the open end of the connectors, **NOT** wire entry end.

NOTE: If your car is equipped with factory console gauges, the wiring of those console gauges can be found in the console wiring kit, 510366.

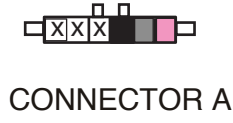

Classic Update Series

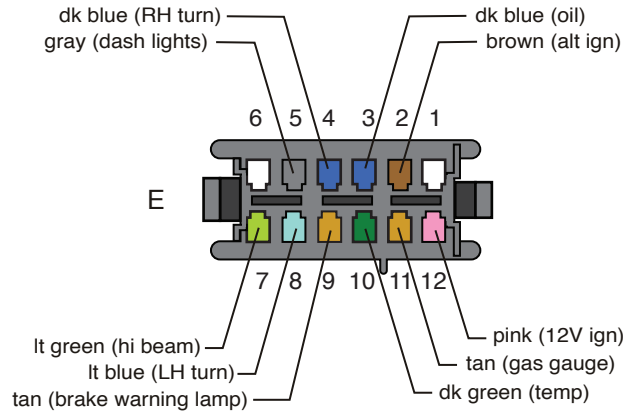

1967 CHEVY ALL FULLSIZE W/ WARNING LAMPS CLUSTER CONNECTIONS

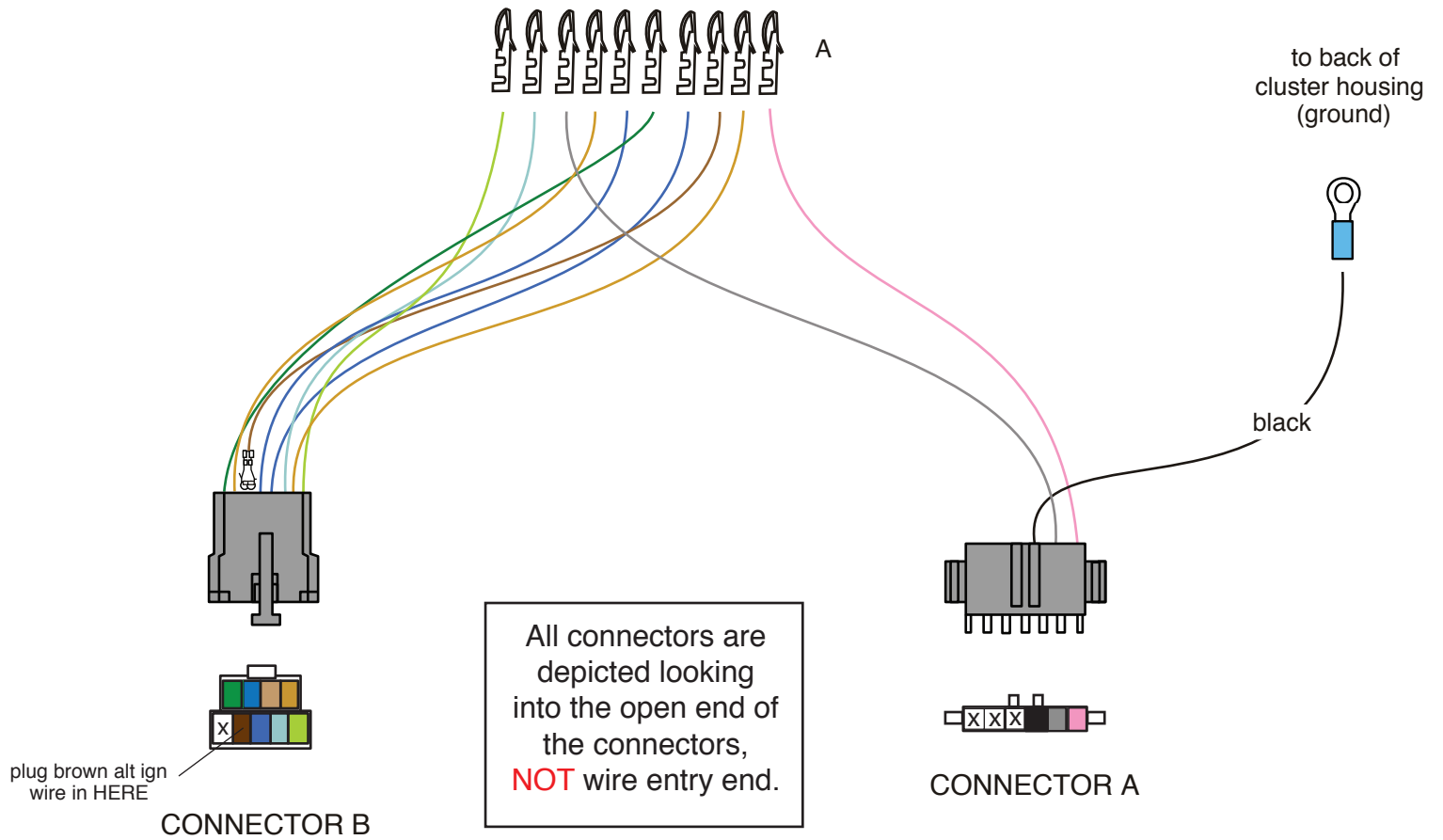

Classic Update Series

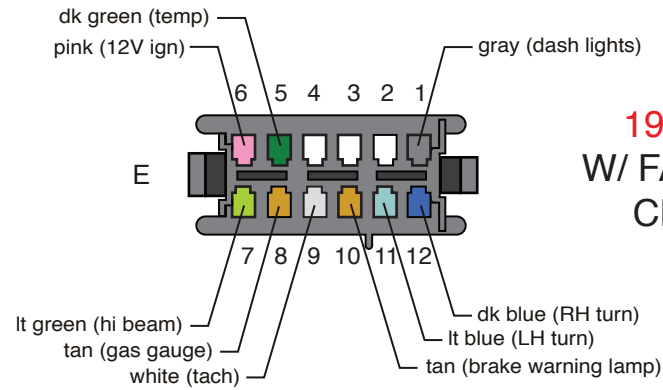

1967 CHEVY ALL FULLSIZE W/ FACTORY IN DASH GAUGES CLUSTER CONNECTIONS

NOTE: This kit does not support the use of the factory ammeter. We suggest the use of a voltmeter to monitor your charging system

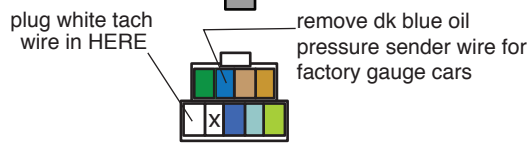

All connectors are depicted looking into the open end of the connectors, **NOT** wire entry end.

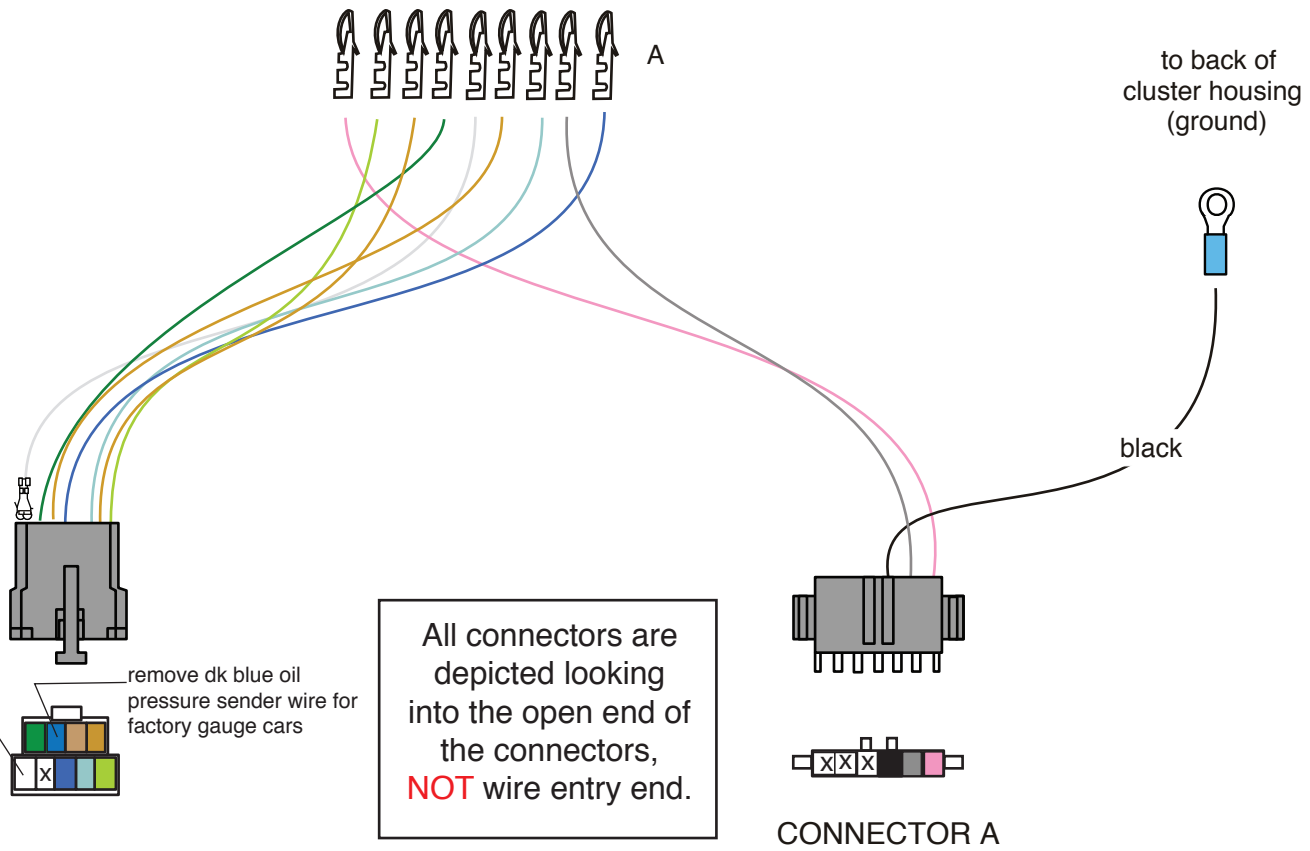

Classic Update Series

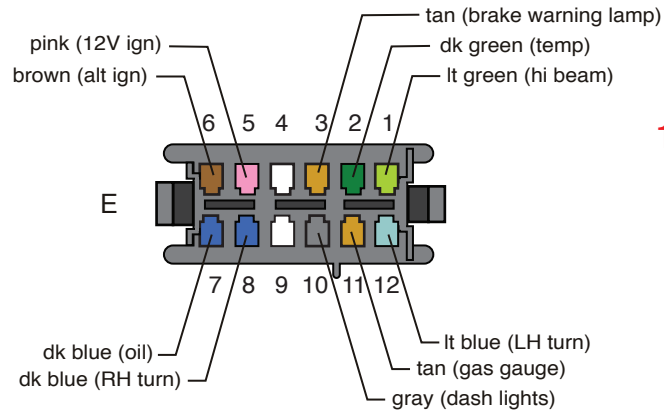

1968 CHEVY ALL FULLSIZE W/ WARNING LAMPS CLUSTER CONNECTIONS

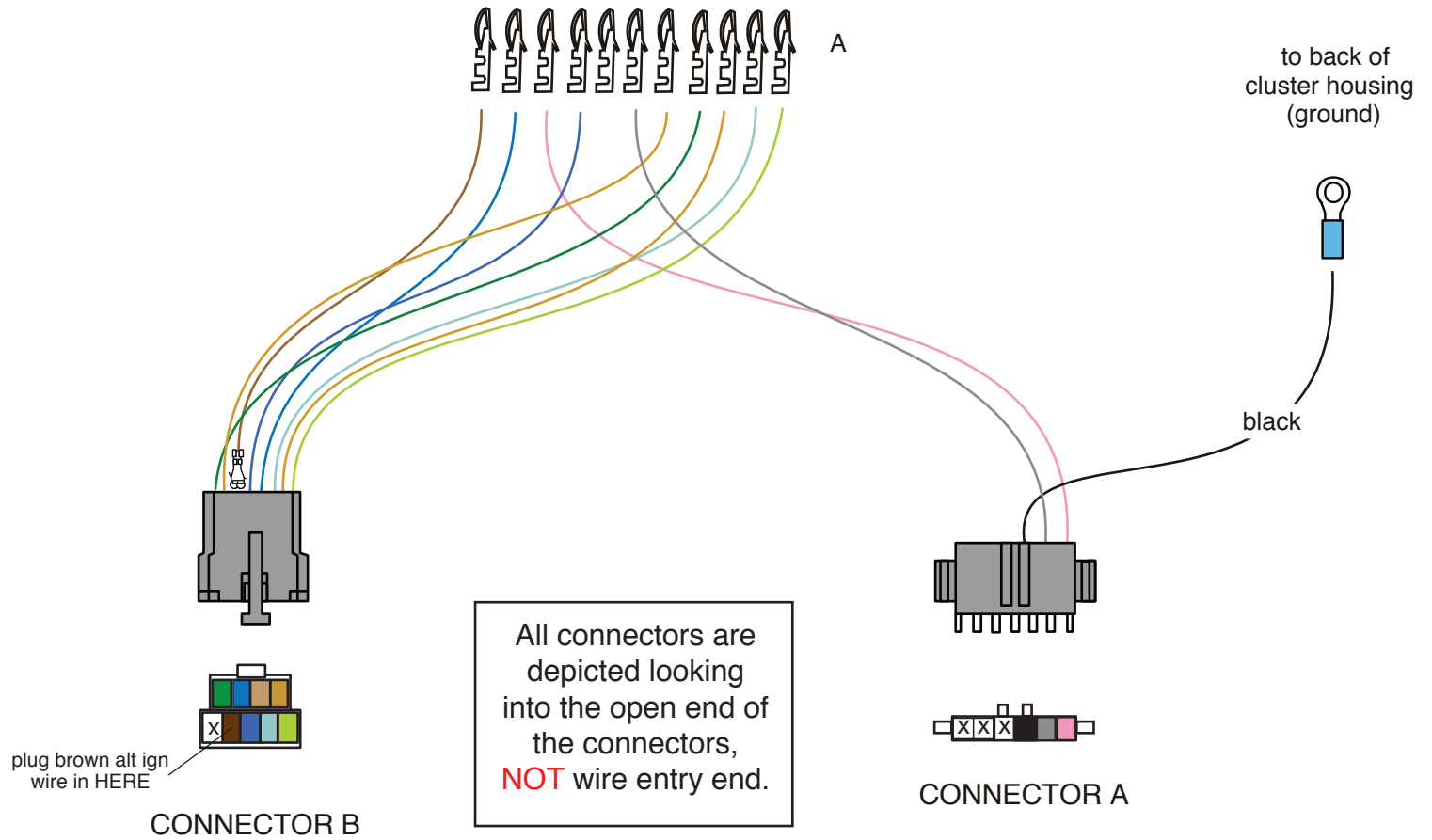

Classic Update Series

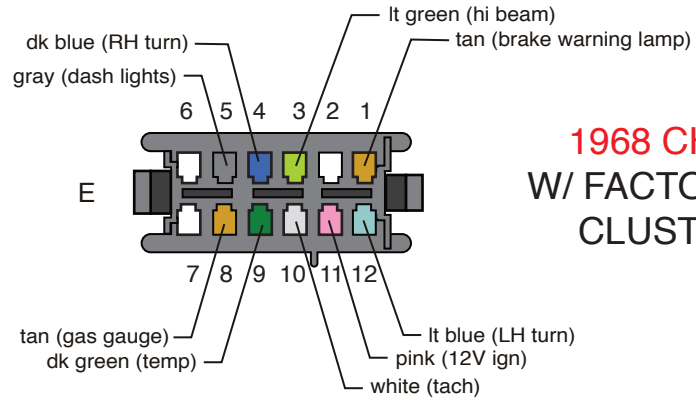

1968 CHEVY ALL FULLSIZE W/ FACTORY IN DASH GAUGES CLUSTER CONNECTIONS

NOTE: This kit does not support the use of the factory ammeter. We suggest the use of a voltmeter to monitor your charging system

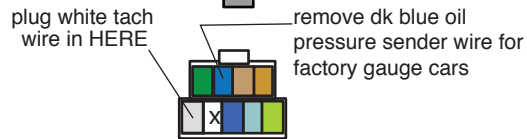

All connectors are depicted looking into the open end of the connectors, **NOT** wire entry end.

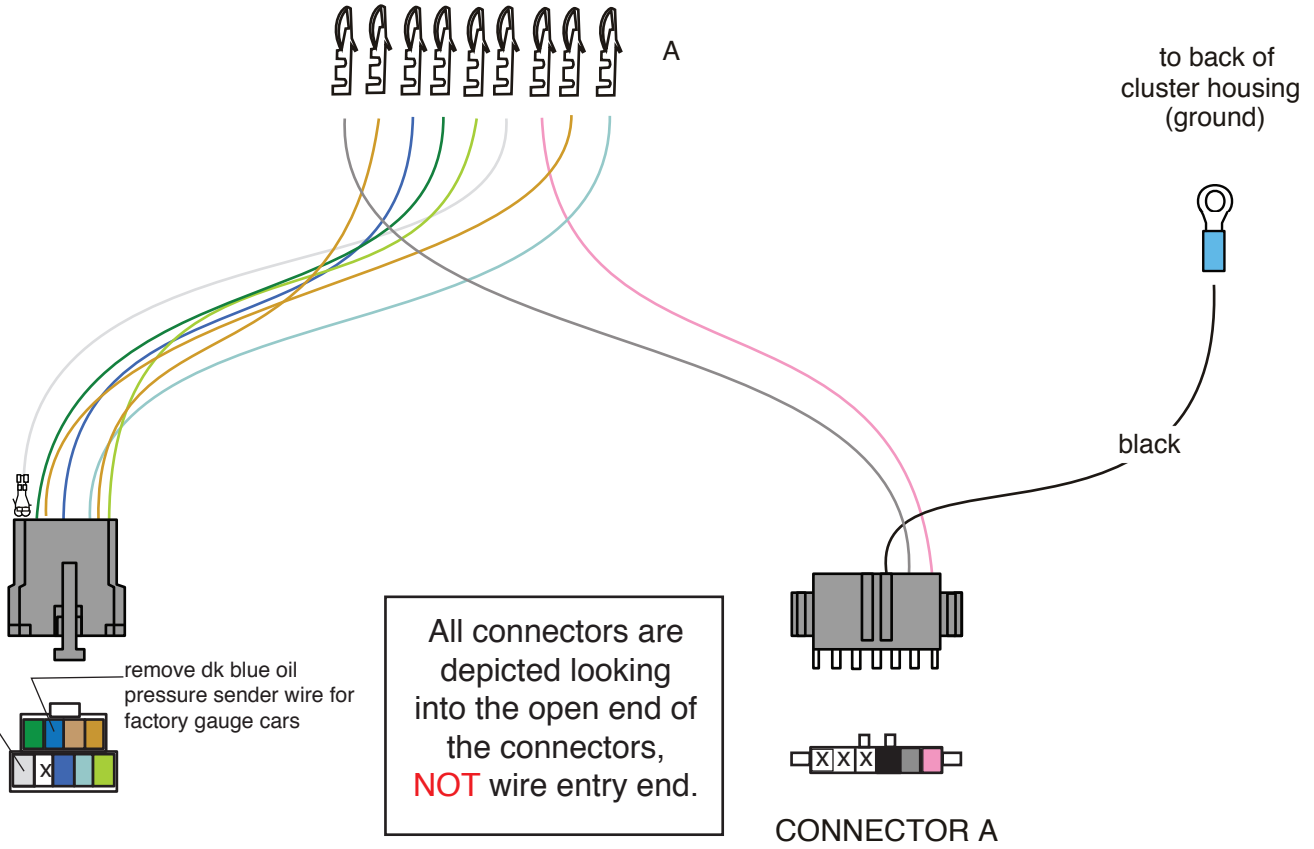

Classic Update Series

Gauge Cluster harness (aftermarket gauges) installation instructions:

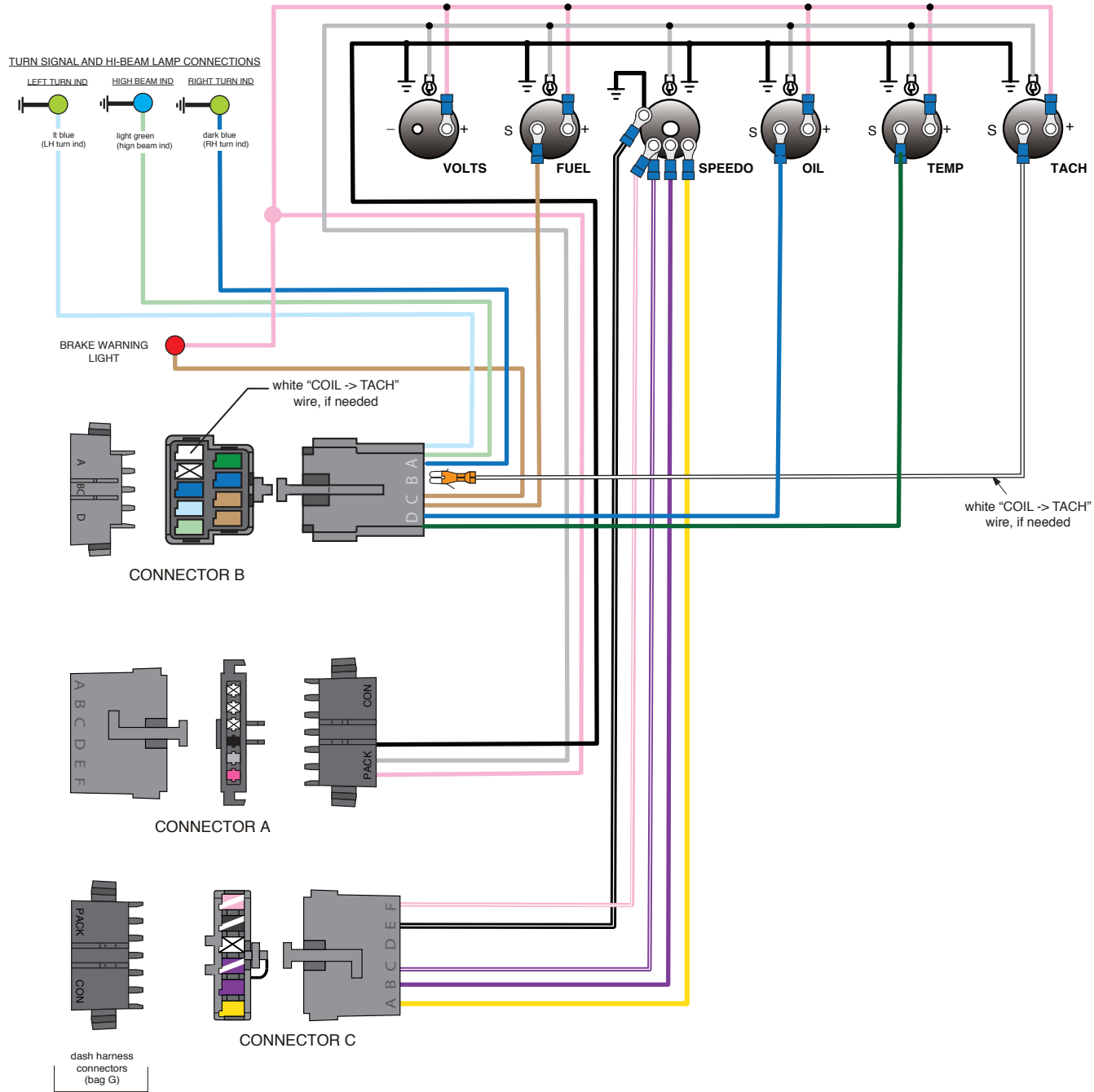



TYPICAL ELECTRIC SPEEDO CONNECTIONS

Below are some general instructions for hooking up an electric speedometer. This connector and these instructions will ONLY be used in the event that you are utilizing an aftermarket electric speedometer. If your car does NOT have an electric speedometer, this connection will NOT be used and should not be plugged onto your dash harness. It is best to consult the speedometer manufacturer's instructions if you have any questions.

<u>Yellow</u>	VSS Ground	Connect to VSS "-" on speedometer.
<u>Purple</u>	VSS Pulse	Connect to VSS input on speedometer.
<u>Purple/White</u>	VSS Power	Connect to 12V power on speedometer.
<u>Black/White</u>	Speedo Ground	Connect to ground on speedometer.
<u>Pink/White</u>	Speedo Power	Connect to 12v power on speedometer. NOTE: This wire will double onto the same stud as the purple/white VSS power wire from above.

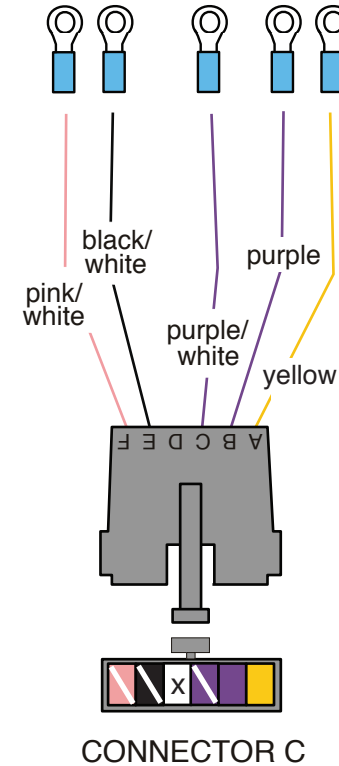

All connectors are depicted looking into the open end of the connectors, **NOT** wire entry end.

Electric Speedo VSS extension connection:

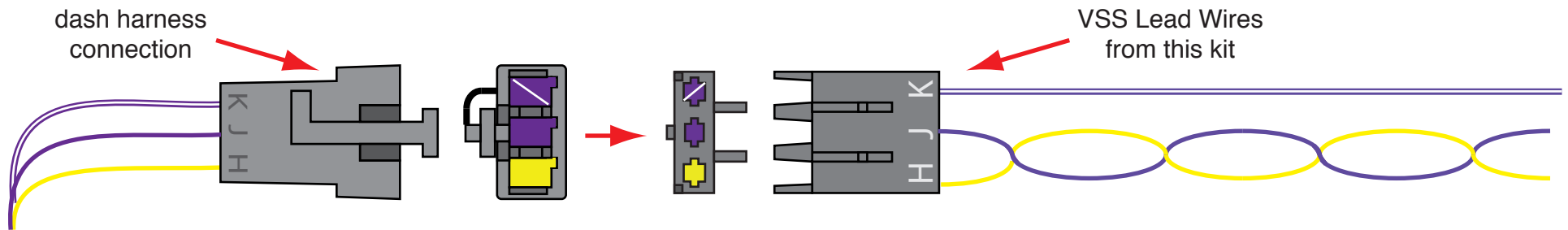

If you are using an aftermarket electric speedometer in your vehicle, you will need to connect the vehicle speed sensor (VSS) Lead Wires from this kit to the dash side connection of your dash harness. The yellow and solid purple wires must remain twisted together as shown above. These three wires will need to pass through the firewall or floor of your vehicle down to the vehicle speed sensor unit in the transmission. Generally, the solid purple wire connects to the “signal” lead, the yellow wire connects to the “ground” lead, and the purple/white stripe wire connects to the “12 volt power” lead on the vehicle speed sensor assembly. However, you should consult the directions that came with your gauges, and connect your vehicle speed sensor per the manufacturer’s instructions.



www.americanautowire.com 856-933-0801

VSS LEAD WIRES
Various Applications
Classic Update Series

510730

92972371 Rev 0.0 4/9/2019

bag
V



This page intentionally left blank.

Classic Update Series

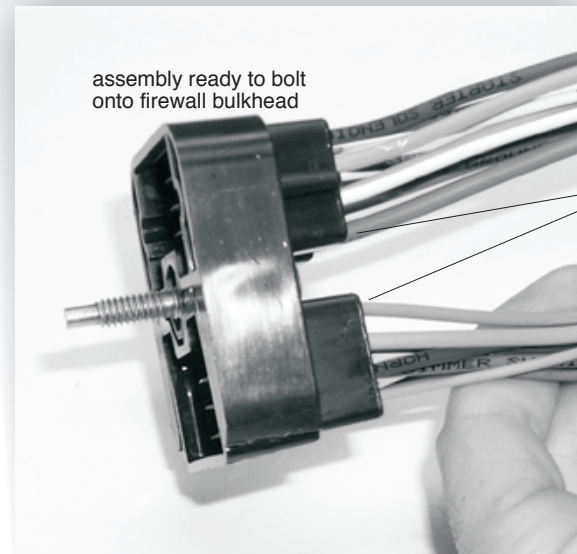
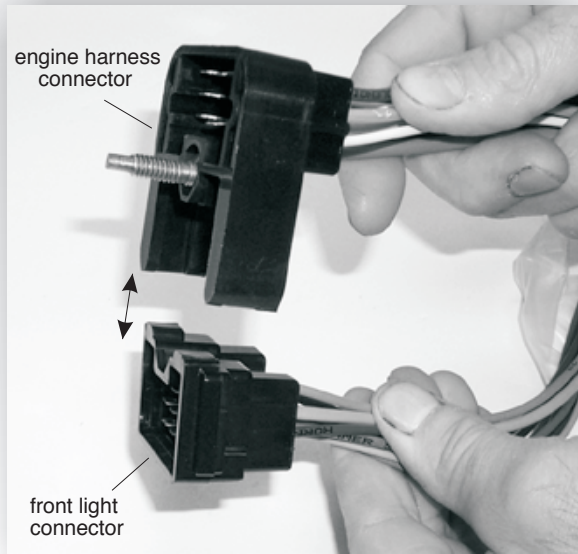

The bulkhead connector from this Engine kit must snap into the mating engine connector (bag L), as shown. After snapping together, then bolt the assembly into the dash harness firewall connector using the attached bolt.

Look!



American Autowire also sells factory OEM style harness wrap. this is the same stuff used on original Camaro harnesses! If you want that OEM look with your Classic Update wiring system, then give us a call and order p/n R0067108 !



**American
Autowire**

www.americanautowire.com 856-933-0801

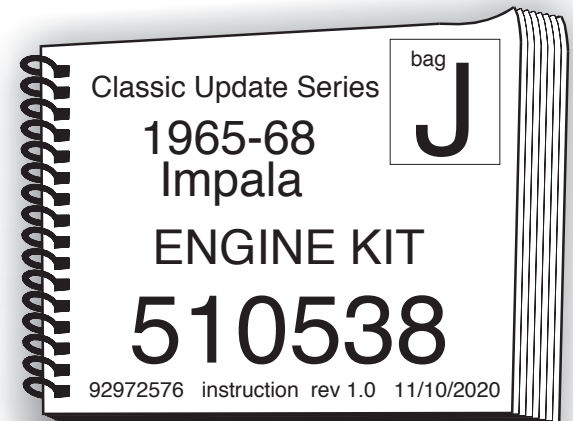

www.americanautowire.com 856-933-0801

Terminals used in this installation.

This kit contains loose piece terminals and connectors necessary to complete a connection to a specific component. Each connection on the instruction sheet identifies specific parts by a letter code that corresponds to the letter code on a part picture identified below. The parts below are shown in actual size to help in identification. This kit will only contain those parts required for the connections in the specific sub-kit you are working on. Just match the part to the picture below to identify the part letter code you will see on the instruction sheet for the sub-kit harness you are working on. We have supplied additional terminals in the event that extra terminals are necessary.

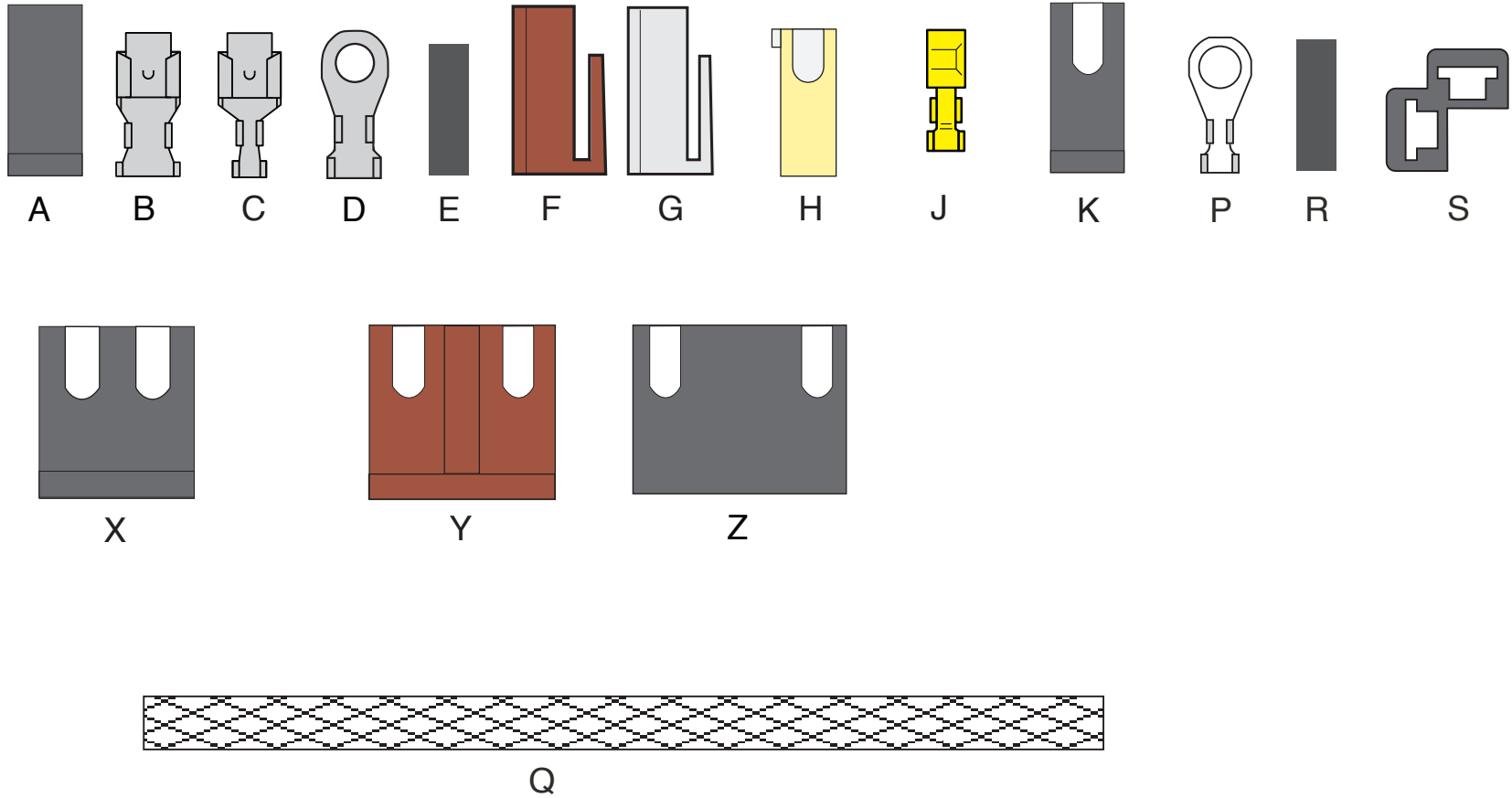

www.americanautowire.com 856-933-0801

ENGINE KIT
510538

92972576 instruction rev 1.0 11/10/2020

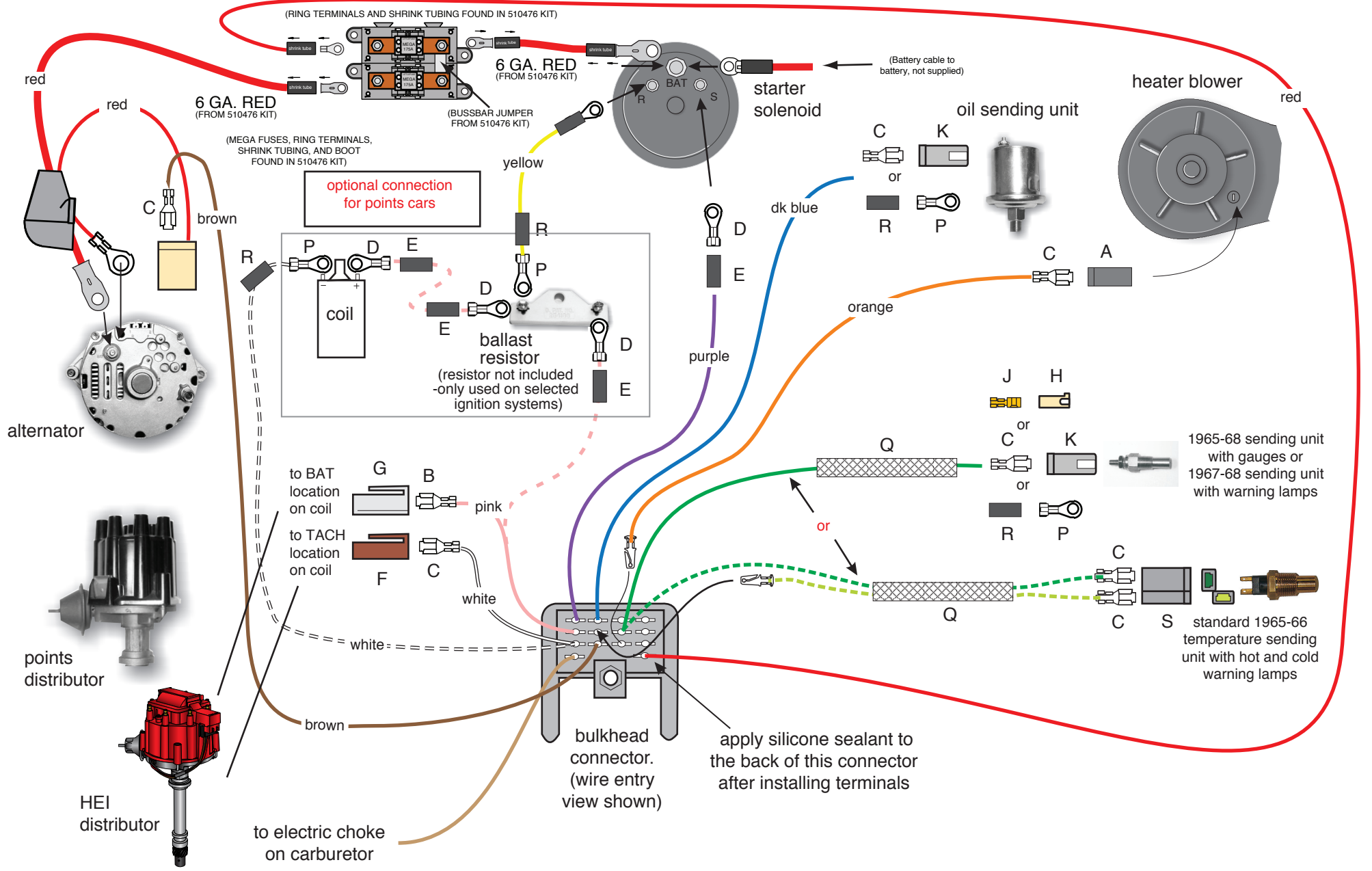

NOTE: Wiper connections are shown on pages 5 & 6 of this instruction set.



ENGINE KIT
510538
 92972576 instruction rev 1.0 11/10/2020

TEMPORARILY, PLUG THE MAIN BULKHEAD CONNECTOR FROM THIS KIT INTO THE MATING CONNECTOR ON THE DASH BULKHEAD CONNECTOR (LOCATED UNDER THE MASTER CYLINDER) Note: This will be unbolted to install the front light harness later.

BULKHEAD CONNECTOR WIRES:

RED	12 V BATTERY	Route this wire to the Megafuse and cut to length. Use ring terminal, shrink tubing from 510476 kit. Connect as shown on page 3.
PURPLE	STARTER SOLENOID	Route to the starter solenoid and cut to length. Install rubber sleeve E and ring terminal D. Connect to the "S" terminal on the solenoid.
PINK	12 V IGNITION	If using an HEI distributor or after-market ignition system that requires a 12 volt feed: Route the PINK wire to the coil and trim to length. Install terminal B and connector and, then plug into the distributor cap BAT location. If using a points type ignition system that requires reduced voltage: Route the PINK wire to the ignition feed side of a ballast resistor (not included). Connect the piece of left over PINK wire to the coil side of the ballast resistor and route to the distributor coil positive (+) side.
YELLOW	STARTER SOLENOID-R	If using a points type ignition system that requires an ignition bypass wire: Connect this loose piece YELLOW wire to the R terminal on the starter and connect the other end to the coil side of the ballast resistor (not included)
HEAVY RED	AMERICAN AUTOWIRE	Use the 6ga red wire, boot and ring terminal from the 510476, route from alternator to the Megafuse and cut to length. Connect as shown on page 3.
SMALL RED		(Used only with a GM "SI" or other internally regulated alternator [except a 1-wire]) Send the ring terminal end of this wire through boot L as shown on sheet 3 and connect to the battery stud on the alternator. Do not plug the connector into the alternator yet. The brown exciter wire will need to be added to this connector before it is plugged in.
BROWN	ALTERNATOR IGN	Route this wire to the alternator and cut to length. Install terminal C and plug into the regulator connector. You can now plug in the regulator connector.
TAN	ELECTRIC CHOKE	Install this loose wire into main connector as shown on page 1 of this instruction set, then route and connect this wire to your electric choke If you are not using an electric choke, remove this wire from the engine bulkhead connector.
ORANGE	HEAT / AIR	(Not used in factory A/C or aftermarket A/C equipped cars. Only used with a stock heater system) Install this loose wire into main connector as shown on page 1 of this instruction set, then route this wire to the heater blower, trim to length, install terminal C, plug into connector A and install onto blower motor.
WHITE	COIL-TACH	(Used only on 65-66 cars with a factory tach, 67-68 cars with factory gauges, or any aftermarket tach application) Install this loose wire into main connector as shown on page 1 of this instruction set, then route this wire to the coil and trim to length. If using an HEI distributor, install terminal C and connector F and then plug into the distributor cap TACH location. If using a conventional coil, terminal P and sleeve R are included for connection to the negative (-) side of the coil.
DARK BLUE	OIL PRESSURE SENDER	(Not used in factory gauge cars) Install this loose wire into main connector as shown on page 1 of this instruction set then connect this wire to the oil pressure sending unit using terminal P and sleeve R or terminal C together with connector K
DARK GREEN	WATER TEMP SENDER	(All with gauges, or 1967-68 with warning lamps) Slide wire through loom Q, then connect this wire to the temp sending unit using terminal P and sleeve R, or terminal C together with connector K, or terminal J together with connector H. (1965-66 with hot and cold warning lamps) Slide wire through loom Q, then connect this wire to the temp sending unit using terminal C, then plug into connector S as shown on page 1 of this instruction set.
LIGHT GREEN	(no printing)	(Used only in 1965-66 with hot and cold warning lamps) Install this loose wire into main connector as shown on page 1 of this instruction set, slide wire through loom Q, then connect this wire to the temp sending unit using terminal C, then plug into connector S as shown on page 1 of this instruction set.

NOTE: For your information, there were 3 different wiper/washer configurations offered between 1965 and 1968 on the Fullsize Chevy models. 1965 single speed without washer, 1965 single speed with washer, and 1965 through 1968 2 speed with washer. Instructions for connection to all three different styles are depicted on pages 5 and 6 of this instruction set.



ENGINE KIT
510538

92972576 instruction rev 1.0 11/10/2020

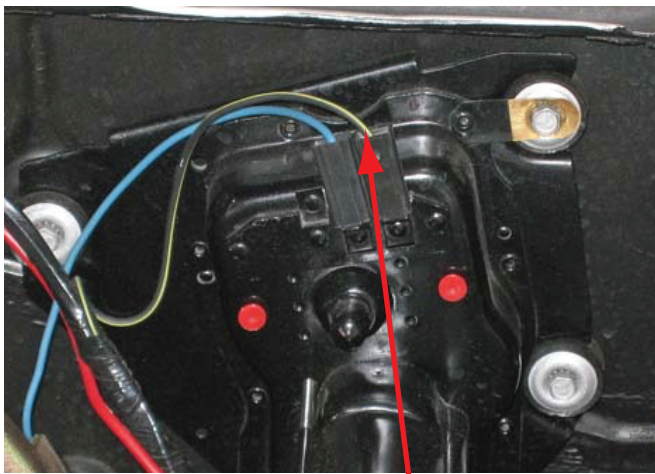

The photo above depicts the typical stock 1965 Impala or other fullsize single speed wiper motor connection. The black with yellow stripe wire in the photo (red arrow) is the equivalent to the AAW white "wiper feed" power wire.

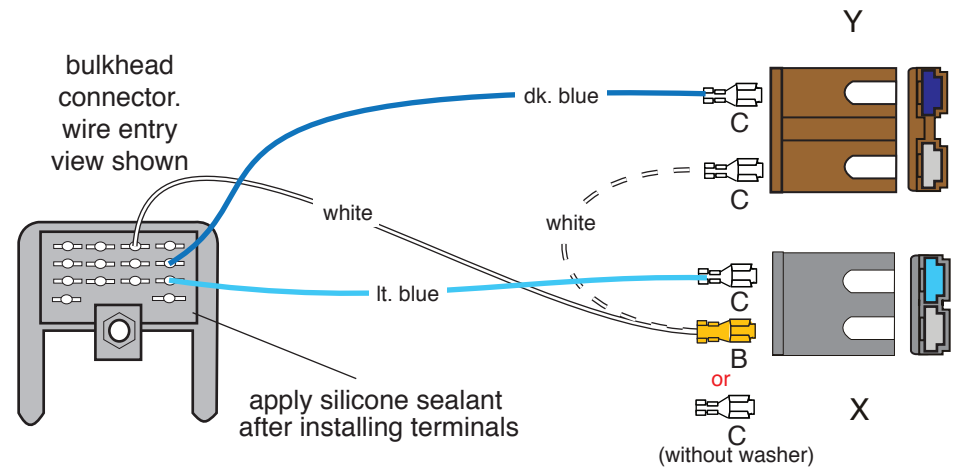

NOTE: Dark blue and white wires denote optional washer pump with single speed wiper system.

WITH WASHER PUMP ASSEMBLY DIRECTIONS:

- WHITE WIPER** Route this wire to the wiper motor, trim to length, double this wire with the cut-off portion, install terminal B, and plug into connector X as shown on this page. Route the remaining portion to the washer pump, trim to length, install terminal C and plug into connector Y as shown on this page.
- LIGHT BLUE WIPER HIGH SPEED GROUND** Route this wire to the wiper motor, trim to length, install terminal C, and plug into connector X as shown on this page.
- DARK BLUE WIPER WASHER GROUND** Route this wire to the washer pump, trim to length, install terminal C, and plug into connector Y as shown on this page.

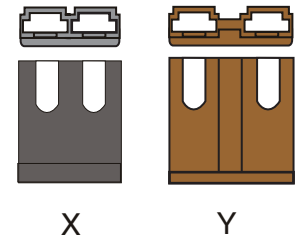

WITHOUT WASHER PUMP ASSEMBLY DIRECTIONS:

- WHITE WIPER** Route this wire to the wiper motor, trim to length, install terminal C and plug into connector X as shown on this page.
- LIGHT BLUE WIPER HIGH SPEED GROUND** Route this wire to the wiper motor, trim to length, install terminal C, and plug into connector X as shown on this page.
- DARK BLUE WIPER WASHER GROUND** This wire will not be used and must be removed from the engine bulkhead connector.

1965 SINGLE SPEED WITH AND WITHOUT WASHER PUMP CONNECTIONS

ENGINE KIT
510538
92972576 instruction rev 1.0 11/10/2020



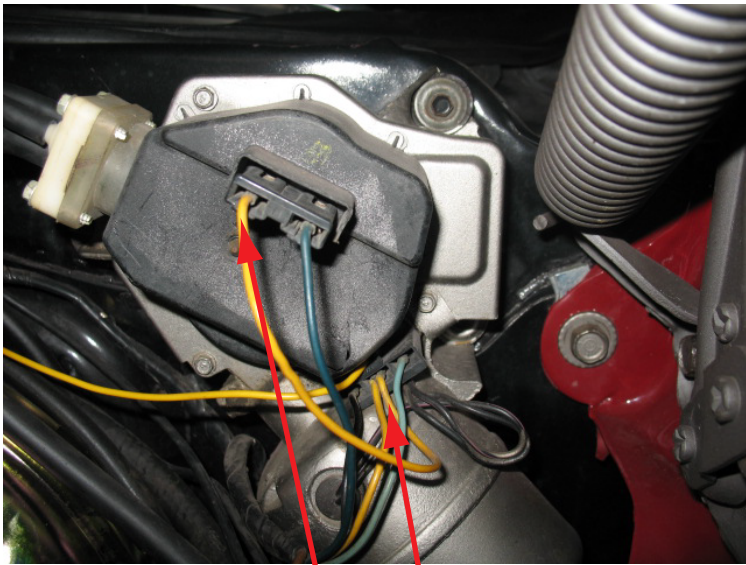

The photo above depicts the typical stock 1965-1968 Impala or other fullsize 2 speed wiper motor and washer pump connections. The yellow wires in the photo (red arrows) are the equivalent to the AAW white "wiper feed" power wire.

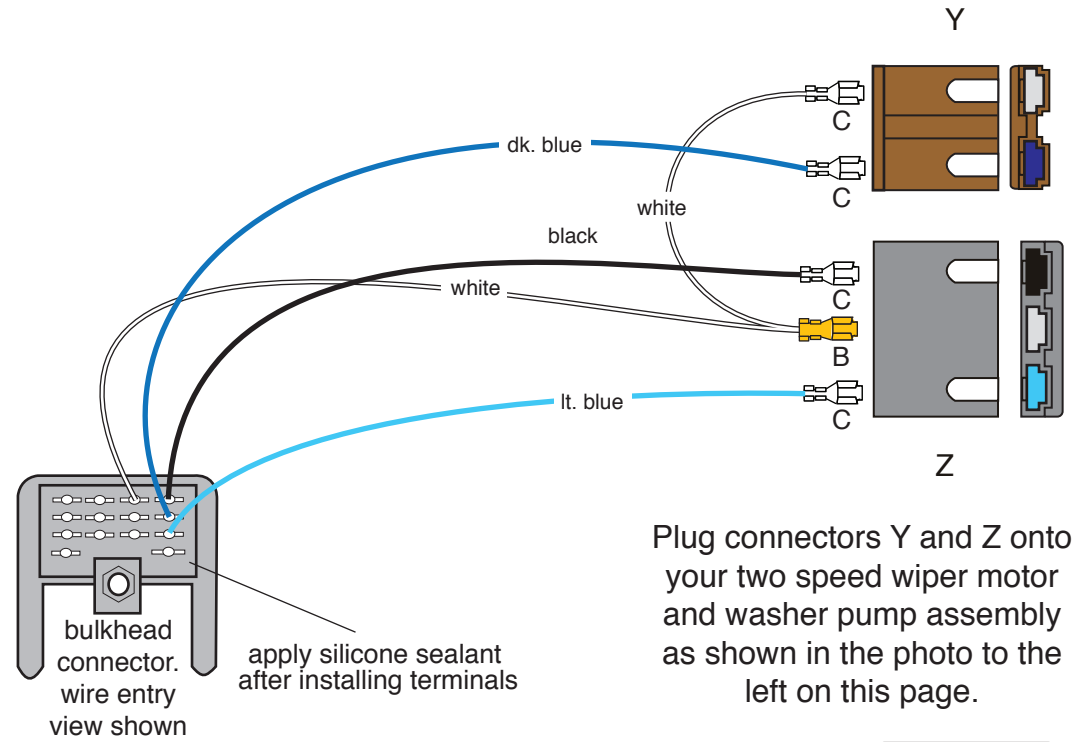

Plug connectors Y and Z onto your two speed wiper motor and washer pump assembly as shown in the photo to the left on this page.

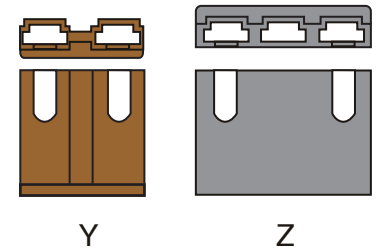

1965 -1968 TWO SPEED WITH WASHER PUMP CONNECTIONS

WHITE	WIPER	Route this wire to the wiper motor, trim to length, double this wire with the cut-off portion, install terminal B, and plug into connector Z as shown on this page. Route the remaining portion to the washer pump, trim to length, install terminal C and plug into connector Y as shown on this page.
BLACK	WIPER LOW SPEED GROUND	Route this wire to the wiper motor, trim to length, install terminal C, and plug into connector Z as shown on this page.
LIGHT BLUE	WIPER HIGH SPEED GROUND	Route this wire to the wiper motor, trim to length, install terminal C, and plug into connector Z as shown on this page.
DARK BLUE	WIPER WASHER GROUND	Route this wire to the washer pump, trim to length, install terminal C, and plug into connector Y as shown on this page.



ENGINE KIT
510538
92972576 instruction rev 1.0 11/10/2020

Terminals used in this installation.

This kit contains loose piece terminals and connectors necessary to complete a connection to a specific component. Each connection on the instruction sheet identifies specific parts by a letter code that corresponds to the letter code on a part picture identified below. The parts below are shown in actual size to help in identification. This kit will only contain those parts required for the connections in the specific sub-kit you are working on. Just match the part to the picture below to identify the part letter code you will see on the instruction sheet for the sub-kit harness you are working on. We have supplied additional terminals in the event that extra terminals are necessary.

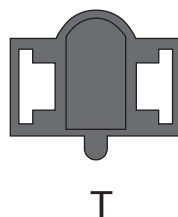
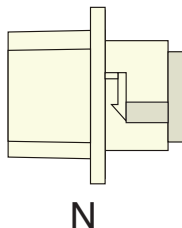
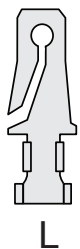
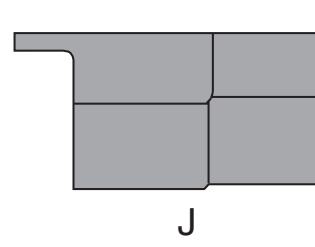
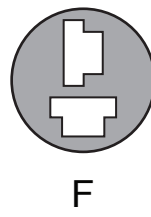
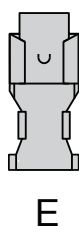
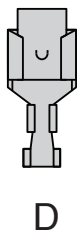
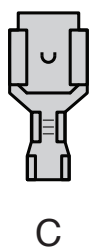
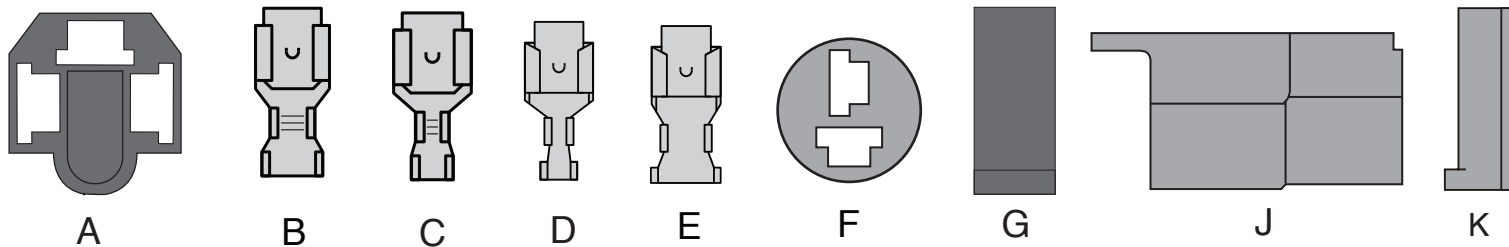

1965-68 Impala
Front Light Kit
510539

92972579 instruction rev 0.0 9/24/2019

Classic Update Series

right headlight

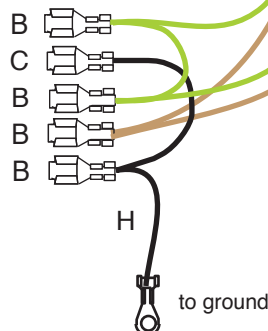
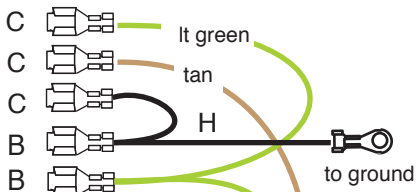
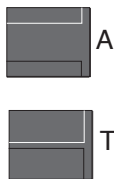

left headlight

right turn signal

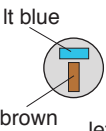
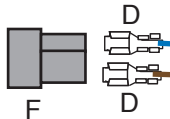
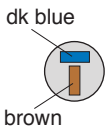

left turn signal

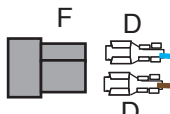

to electric fan orange recommended fan relay (not included in this kit)

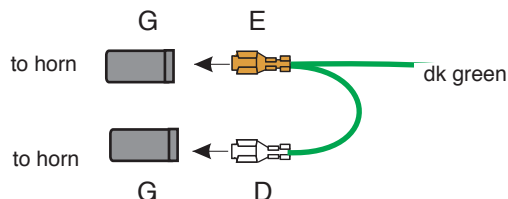

lt green tan

apply silicone sealant to wire entry side of connector after installing terminals

bulkhead connector (wire entry view)

connect to brake pressure sending unit if needed tan Q

1965-66 Chevy Fullsize Front Light

1965-66 Chevy Fullsize

NOTE: See sheet 8 for directions regarding the connection of the Yellow, Purple, and Purple/White Stripe electric speedo wires.

Assemble the bulkhead connector from this kit to the bulkhead connector from the engine kit (510363, bag J), then bolt them to the main firewall bulkhead. After all wires are installed from this kit, apply die-electric grease to the terminals and silicone sealer to the outside of the connectors as a moisture seal.

LIGHT BLUE	LEFT FRONT TURN	Route this wire to the LH parking lamp area, trim to length, install terminal D and plug this wire into connector F as shown on sheet 3.
DARK BLUE	RIGHT FRONT TURN	Route this wire to the RH parking lamp area, trim to length, install terminal D and plug this wire into connector F as shown on sheet 3.
BROWN	PARK LIGHTS	Route the shorter brown wire to the LH parking lamp area, trim to length, install terminal D and plug into connector F as shown on sheet 3. Route the longer brown wire to the RH parking lamp area, trim to length, install terminal D and plug into connector F as shown on sheet 3.
TAN	HEADLIGHT LOW BEAM	Route this wire to the driver side outer headlight and trim to length. Double this wire with the cutoff portion, install terminal B, and plug this terminal into connector A as shown on sheet 3. Route the remaining portion of this TAN wire to the passenger side outer headlight and trim to length. Install terminal C and plug into connector A as shown on sheet 3.
LIGHT GREEN	HEADLIGHT HIGH BEAM	Route this wire to the driver side outer headlight, trim to length, double this wire with the cutoff portion, install terminal B, and plug this terminal into connector A as shown on sheet 3. Route the remaining portion of this Lt green wire to the driver side inner headlight, trim to length, double this wire with the cutoff portion, install terminal B, and plug this terminal into connector T as shown on sheet 3. Route the remaining portion of this Lt green wire to the passenger side inner headlight, trim to length, double this wire with the cutoff portion, install terminal B, and plug this terminal into connector T as shown on sheet 3. Route the remaining portion of this Lt green wire to the passenger side outer head light, trim to length, install terminal C, and plug this terminal into connector A as shown on sheet 3.
BLACK	GROUND	Starting with the ring terminal, find the grounding location for this wire H (do not attach it to the car yet) then route this wire to the driver side outer headlight and trim to length. Double this wire with the cutoff portion, install terminal B, and plug this terminal into connector A as shown on sheet 3. Route the remaining portion of this black wire to the driver side inner headlight, trim to length, install terminal C, and plug this terminal into connector T as shown on sheet 3. Attach the ring terminal to the ground location. Repeat this process for the passenger side headlights.
DARK GREEN	HORN	Route this wire to one horn, trim to length, double it with the cutoff portion, install terminal E, and plug this terminal into connector G as shown on sheet 3. Route the remaining portion of this dk green wire to the second horn, trim to length, install terminal D and plug into connector G as shown on sheet 3. Plug connectors G onto your horns.
TAN	BRAKE LIGHT SWITCH	If your car is equipped with a brake warning system, plug this wire Q into the main connector as shown on sheet 3, and splice the other end onto your brake sender switch connection (brake switch connection not included in kit).
ORANGE	ELECTRIC FAN	Route this wire to the electric fan relay and connect per the manufacturer's instructions. NOTE: We recommend that this wire be used as the trigger wire for the electric fan relay.

After all wires are installed from this kit, the main connector should have die-electric grease applied to the terminals. Also, to assure a moisture resistance seal, apply silicone sealant to the outside of the main connector around each wire.

1965-66 Chevy Fullsize Front Light

Classic Update Series

right headlight

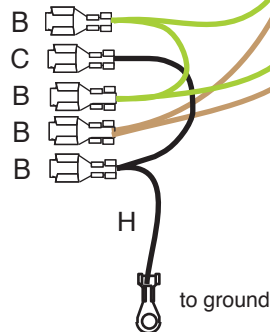
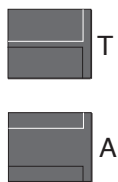
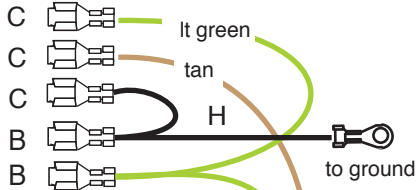
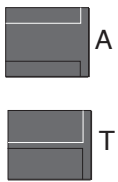

left headlight

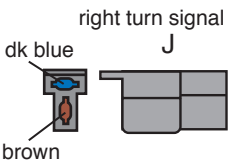

right turn signal

dk blue
brown

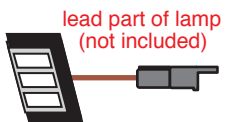
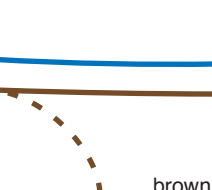
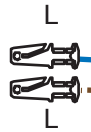

lead part of lamp
(not included)

(w/optional RH T-78 fender lamp)

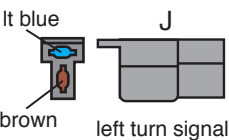

left turn signal

lt blue
brown

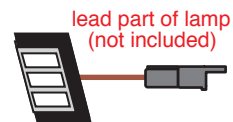
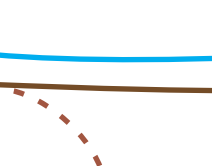
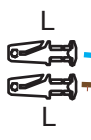

lead part of lamp
(not included)

(w/optional LH T-78 fender lamp)



to electric fan



recommended fan relay
(not included in this kit)



to horn



dk green



to horn



dk green

lt green

tan

apply silicone sealant to
wire entry side of connector
after installing terminals

bulkhead
connector
(wire entry
view)

connect to brake
pressure sending
unit if needed

tan



dk blue

brown

lt blue

brown

1967 Chevy Fullsize Front Light

1967 Chevy Fullsize

NOTE: See sheet 8 for directions regarding the connection of the Yellow, Purple, and Purple/White Stripe electric speedo wires.

Assemble the bulkhead connector from this kit to the bulkhead connector from the engine kit (510363, bag J), then bolt them to the main firewall bulkhead. After all wires are installed from this kit, apply die-electric grease to the terminals and silicone sealer to the outside of the connectors as a moisture seal.

LIGHT BLUE	LEFT FRONT TURN	Route this wire to the LH parking lamp area, trim to length, install terminal L and plug this wire into connector J as shown on sheet 5.
DARK BLUE	RIGHT FRONT TURN	Route this wire to the RH parking lamp area, trim to length, install terminal L and plug this wire into connector J as shown on sheet 5.
BROWN	PARK LIGHTS	Route the shorter brown wire to the LH parking lamp area, trim to length, install terminal L and plug into connector J as shown on sheet 5. Route the longer brown wire to the RH parking lamp area, trim to length, install terminal L and plug into connector J as shown on sheet 5.

NOTE: If your car has the T-78 fender lamp option, route the shorter brown wire to the LH fender lamp area, trim to length, double it with the cut off portion, install terminal E, plug that terminal into connector K, then plug connector K into the LH fender lamp lead. Route the remaining portion of that brown wire to the LH parking lamp area, install terminal L and plug into connector J as shown on sheet 5. Repeat this process for the RH fender and parking lamp connections using the longer brown wire.

TAN	HEADLIGHT LOW BEAM	Route this wire to the driver side outer headlight and trim to length. Double this wire with the cutoff portion, install terminal B, and plug this terminal into connector A as shown on sheet 4. Route the remaining portion of this TAN wire to the passenger side outer headlight and trim to length. Install terminal C and plug into connector A as shown on sheet 5.
LIGHT GREEN	HEADLIGHT HIGH BEAM	Route this wire to the driver side outer headlight, trim to length, double this wire with the cutoff portion, install terminal B, and plug this terminal into connector A as shown on sheet 5. Route the remaining portion of this Lt green wire to the driver side inner headlight, trim to length, double this wire with the cutoff portion, install terminal B, and plug this terminal into connector T as shown on sheet 5. Route the remaining portion of this Lt green wire to the passenger side inner headlight, trim to length, double this wire with the cutoff portion, install terminal B, and plug this terminal into connector T as shown on sheet 5. Route the remaining portion of this Lt green wire to the passenger side outer headlight, trim to length, install terminal C, and plug this terminal into connector A as shown on sheet 5.
BLACK	GROUND	Starting with the ring terminal, find the grounding location for this wire H (do not attach it to the car yet) then route this wire to the driver side outer headlight and trim to length. Double this wire with the cutoff portion, install terminal B, and plug this terminal into connector A as shown on sheet 5. Route the remaining portion of this black wire to the driver side inner headlight, trim to length, install terminal C, and plug this terminal into connector T as shown on sheet 5. Attach the ring terminal to the ground location. Repeat this process for the passenger side headlights.
DARK GREEN	HORN	Route this wire to one horn, trim to length, double it with the cutoff portion, install terminal E, and plug this terminal into connector G as shown on sheet 4. Route the remaining portion of this dk green wire to the second horn, trim to length, install terminal D and plug into connector G as shown on sheet 5. Plug connectors G onto your horns.
TAN	BRAKE LIGHT SWITCH	Plug this wire into the main connector as shown on sheet 6, and splice the other end onto your brake sender switch connection (brake switch connection not included in kit).
ORANGE	ELECTRIC FAN	Route this wire to the electric fan relay and connect per the manufacturer's instructions. NOTE: We recommend that this wire be used as the trigger wire for the electric fan relay.

After all wires are installed from this kit, the main connector should have die-electric grease applied to the terminals. Also, to assure a moisture resistance seal, apply silicone sealant to the outside of the main connector around each wire.

1967 Chevy Fullsize Front Light

1968 Chevy Fullsize

Assemble the bulkhead connector from this kit to the bulkhead connector from the engine kit (510363, bag J), then bolt them to the main firewall bulkhead. After all wires are installed from this kit, apply die-electric grease to the terminals and silicone sealer to the outside of the connectors as a moisture seal.

LIGHT BLUE	LEFT FRONT TURN	Route this wire to the LH parking lamp, trim to length, install terminal L and plug this wire into connector J as shown on sheet 7.
DARK BLUE	RIGHT FRONT TURN	Route this wire to the RH parking lamp, trim to length, install terminal L and plug this wire into connector J as shown on sheet 7.
BROWN	PARK LIGHTS	<p>(ALL except with T-78 fender lamps) Route one brown wire to the LH side marker lamp area, trim to length, double this wire with the cutoff portion, install terminal M and plug this into the LH side marker lamp socket assembly N as shown on sheet 7. Route the remaining portion of this brown wire to the LH parking lamp area, install terminal L and plug into connector J as shown on sheet 7. Route the other brown wire to the RH side marker lamp area, trim to length, double this wire with the cutoff portion, install terminal M and plug this terminal into the RH side marker lamp socket assembly N as shown on sheet 7. Route the remaining portion of this brown wire to the RH parking lamp area, install terminal L and plug into connector J as shown on sheet 7. Plug in the black side marker ground wires P into the side marker lamp socket assemblies N and attach each side marker ground wire ring terminal to a good chassis ground.</p> <p>(ALL with T-78 fender lamps) Route one brown wire to the LH side marker lamp area, trim to length, double this wire with the cutoff portion, install terminal M and plug this terminal into the LH side marker lamp socket assembly N as shown on sheet 7. Route the remaining portion of this brown wire to the LH fender lamp area, trim to length, double it with the cut off portion, install terminal E, plug that terminal into connector K, then plug connector K into the LH fender lamp lead. Route the remaining portion of this brown wire to the LH parking lamp area, trim to length, install terminal L and plug into connector J as shown on sheet 7. Route the other brown wire to the RH side marker lamp area, trim to length, double this wire with the cutoff portion, install terminal M and plug this terminal into the RH side marker lamp socket assembly N as shown on sheet 7. Route the remaining portion of this brown wire to the RH fender lamp area, trim to length, double it with the cut off portion, install terminal E, plug that terminal into connector K, then plug connector K into the RH fender lamp lead. Route the remaining portion of this longer brown wire to the RH parking lamp area, trim to length, install terminal L and plug into connector J as shown on sheet 7. Plug in the black side marker ground wires P into the side marker lamp socket assemblies N and attach each side marker ground wire ring terminal to a good chassis ground.</p>
TAN	HEADLIGHT LOW BEAM	Route this wire to the driver side outer headlight and trim to length. Double this wire with the cutoff portion, install terminal B, and plug this terminal into connector A as shown on sheet 7. Route the remaining portion of this tan wire to the passenger side outer headlight and trim to length. Install terminal C and plug into connector A as shown on sheet 7.
LIGHT GREEN	HEADLIGHT HIGH BEAM	Route this wire to the driver side outer headlight, trim to length, double this wire with the cutoff portion, install terminal B, and plug this terminal into connector A as shown on sheet 7. Route the remaining portion of this light green wire to the driver side inner headlight, trim to length, double this wire with the cutoff portion, install terminal B, and plug this terminal into connector T as shown on sheet 7. Route the remaining portion of this light green wire to the passenger side inner headlight, trim to length, double this wire with the cutoff portion, install terminal B, and plug this terminal into connector T as shown on sheet 7. Route the remaining portion of this light green wire to the passenger side outer headlight, trim to length, install terminal C, and plug this terminal into connector A as shown on sheet 7.
BLACK	GROUND	Starting with the ring terminal, find the grounding location for this wire H (do not attach it to the car yet) then route this wire to the driver side outer headlight and trim to length. Double this wire with the cutoff portion, install terminal B, and plug this terminal into connector A as shown on sheet 7. Route the remaining portion of this black wire to the driver side inner headlight, trim to length, install terminal C, and plug this terminal into connector T as shown on sheet 7. Attach the ring terminal to the ground location. Repeat this process for the passenger side headlights.
DARK GREEN	HORN	Route this wire to one horn, trim to length, double it with the cutoff portion, install terminal E, and plug this terminal into connector G as shown on sheet 7. Route the remaining portion of this dark green wire to the second horn, trim to length, install terminal D and plug into connector G as shown on sheet 7. Plug connectors G onto your horns.
TAN	BRAKE LIGHT SWITCH	Plug this wire into the main connector as shown on sheet 6, and splice the other end onto your brake sender switch connection (brake switch connection not included in kit).
ORANGE	ELECTRIC FAN	Route this wire to the electric fan relay and connect per the manufacturer's instructions. NOTE: We recommend that this wire be used as the trigger wire for the electric fan relay.

After all wires are installed from this kit, the main connector should have die-electric grease applied to the terminals. Also, to assure a moisture resistance seal, apply silicone sealant to the outside of the main connector around each wire.

1968 Chevy Fullsize Front Light

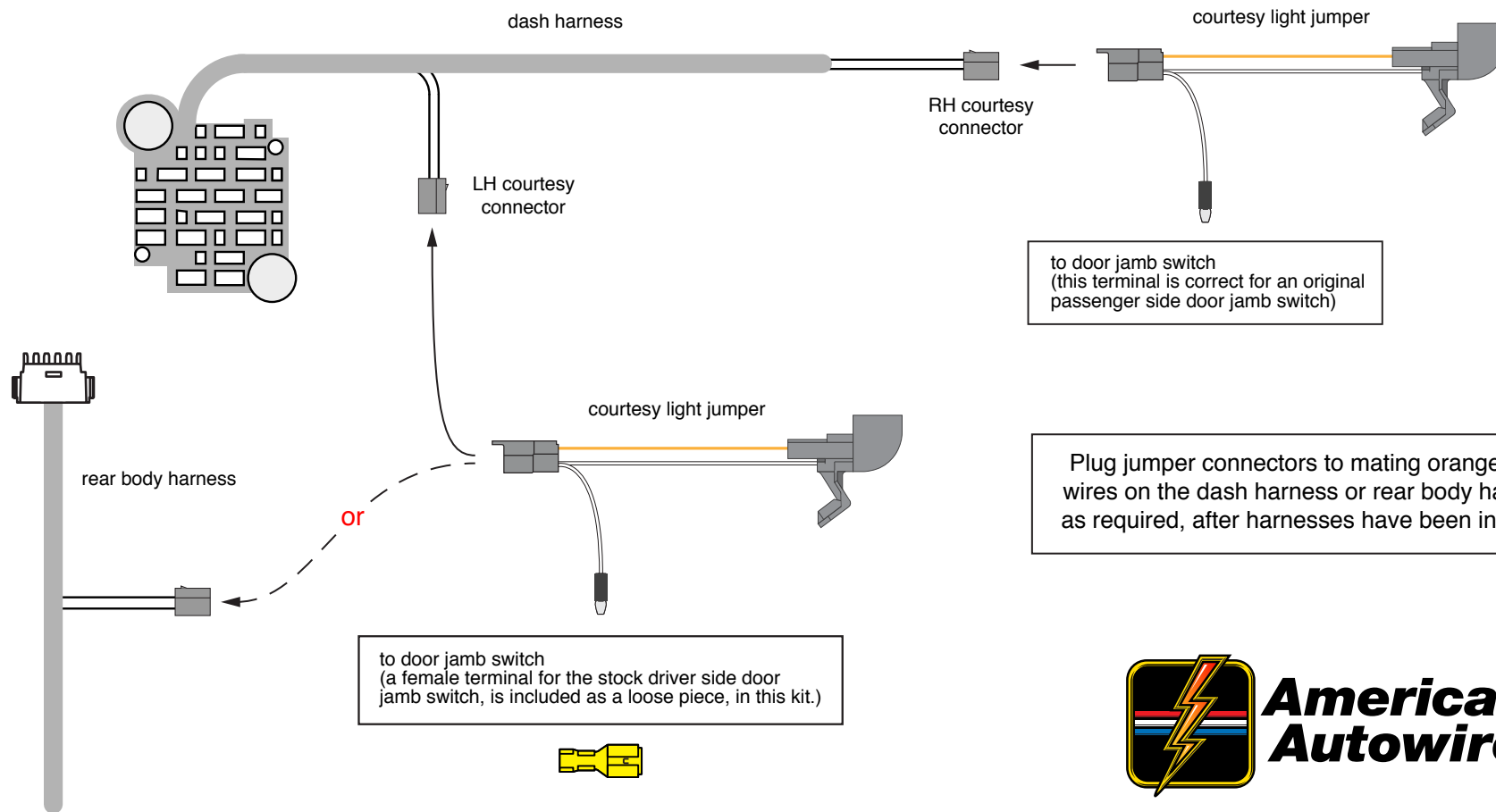

to door jamb switch
(this terminal is correct for an original passenger side door jamb switch)

Plug jumper connectors to mating orange/white wires on the dash harness or rear body harness, as required, after harnesses have been installed.

to door jamb switch
(a female terminal for the stock driver side door jamb switch, is included as a loose piece, in this kit.)



**American
Autowire**

www.americanautowire.com 856-933-0801

NOTE: Your new underdash courtesy light kit uses # 631 bulbs (not included with this kit). They may be purchased at any auto parts store.

PART #	500708	N
DESCRIPTION:	Courtesy Light Kit	
92966085	Rev 1.1	6/27/2016

Classic Update Series

On the next 12 pages, you will find several detailed specialized instructions that will help you install a stock automatic or 4 speed console assembly into your 1965-68 Impala SS or Caprice using this harness kit along with our dash harness kit, P/N 510361, from our 510360 1965 Impala, or our 510372 1966-68 Impala Classic Update wiring kits. Please look at the top of each page and find the correct application for your car. Most all are unique and each installation application is clearly spelled out along with a visual diagram of all of the connections. Some are a bit more complicated than others, so please read everything applicable to your car very carefully before starting this part of the installation. Any of the necessary terminals and connectors needed to complete the installation of each of the many different applications has been included in this kit. They are all shown below and on the individual installation pages. Nothing more will be needed.

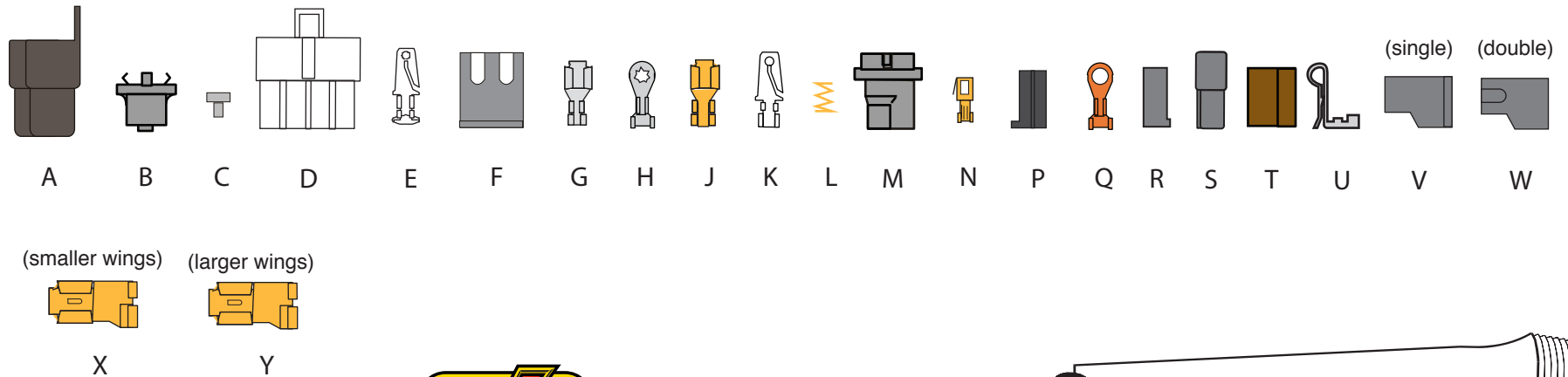

**American
Autowire**

www.americanautowire.com 856-933-0801

Classic Update Series
1965-68 IMPALA
console extension kit
installation instructions

510366

92970260 instruction rev 0.0 3/22/2013

1965 CONSOLE CONNECTIONS WITH MANUAL TRANSMISSION

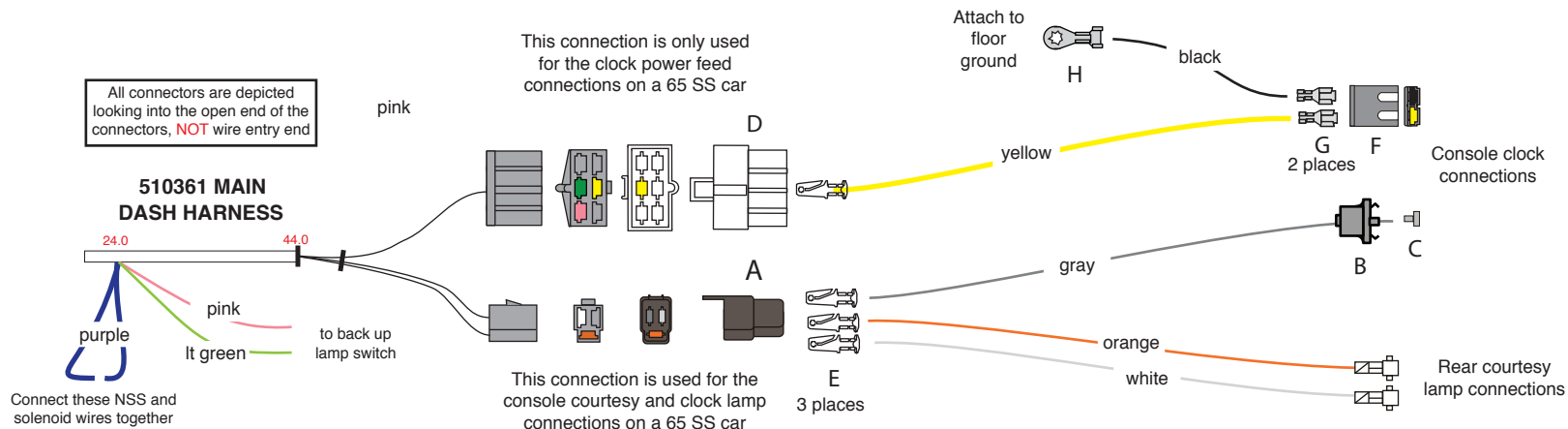

1. At branch number 6 of the main dash harness instruction set, 510361, locate items number 19 & 20. There is a 3-way connector containing orange, white, and gray wires (this is your console courtesy and illumination connection) and a 6-way connector containing yellow, pink, and dark green wires (this is your clock power feed connection). Locate the two heavy gauge purple wires at branch 4. These wires are your neutral safety switch wires, and they must be connected together so that the car will start. Locate the pink and light green wires at branch 4. Connect these wires to the factory back up lamp switch so that your back up lamps will operate.
2. Crimp terminal E onto the loose gray "dash lights" wire from this kit, then plug it into the loose 3-way connector A of this new "console courtesy extension harness (510366)" maintaining color continuity with the dash harness. Route the other end of this gray wire down to the clock area, trim to length, slide lamp socket B onto the wire, then crimp rivet C onto the wire.
3. Snap the orange (12v fused battery) and white (courtesy ground) wires with the courtesy lamp bulb terminals installed on them into the console body, route the loose ends of those wires back up to the main console courtesy 3-way connector area (containing orange, white, and gray wires) on the dash harness and trim to length. Install terminals E on these 2 wires and then plug them into the 3-way connector A from step 2 above maintaining color continuity with the dash harness. Snap your original courtesy lamp bulb into the 2 terminals that you just installed into the console body.
4. Plug the loose yellow (clock battery) wire from this kit into the 6-way connector D of this new "console extension harness, 510366" maintaining color continuity with the dash harness. Route the other end of this yellow wire down to the clock, trim to length, install terminal G and plug this wire into connector F as shown above on this instruction set. This is your clock power connection.
5. Route the black (ground) wire to the clock power connection from step 4 above, install terminal G and plug it into the open cavity of connector F as shown above. Route the opposite end of this wire to the "floor ground" eyelet location on the forward console floor mounting bracket (just as original the was done), trim to length, install ring terminal H on this black wire, then attach it to the "floor ground" location to complete the main ground for this harness. Plug the completed connector F onto the clock assembly.
6. Plug connectors A and D from this console kit onto the mating connectors at the dash harness to complete the console harness connection.



www.americanautowire.com 856-933-0801

console extension kit
installation instructions

1965-68 IMPALA

510366

92970260 instruction rev 0.0 3/22/2013

1965 CONSOLE CONNECTIONS WITH AUTOMATIC TRANSMISSION

All connectors are depicted looking into the open end of the connectors, NOT wire entry end

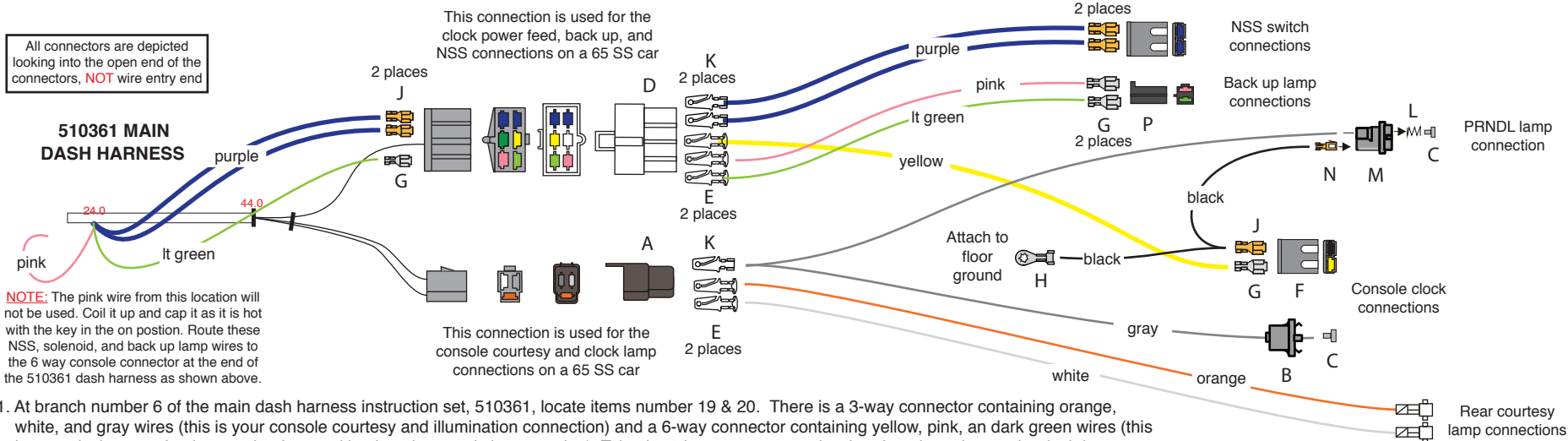

- At branch number 6 of the main dash harness instruction set, 510361, locate items number 19 & 20. There is a 3-way connector containing orange, white, and gray wires (this is your console courtesy and illumination connection) and a 6-way connector containing yellow, pink, an dark green wires (this is your clock power feed, neutral safety, and back up lamp switch connection). Take the 2 heavy gauge purple wires from branch 4 on the dash harness, route them down to the 6-way connector, install terminals J, and plug them into the 6-way connector as shown above. They can install into either of the 2 cavities shown, as no indexing is required. Take the light green wire from branch 4 on the dash harness, route it down to the 6-way connector, install terminal G, and plug it into the empty cavity on the 6-way connector as shown above. The pink wire at branch 4 will not be used and must be coiled up and capped, as it is hot when the key is in the "ON" position.
- Take the loose gray "dash lights" wire from this kit and cut it in half. Double these wires together, install terminal K (solder this connection), and plug those wires into the loose 3-way connector A of this new "console courtesy extension harness (510366)" maintaining color continuity with the dash harness. Route one of the gray wires down to the clock area, trim to length, slide lamp socket B onto the wire, then crimp on rivet C. Route the other gray wire down to the "PRNDL" transmission indicator area, trim to length, install lamp socket M, spring L, then crimp rivet C onto the wire.
- Snap the orange (12v fused battery) and white (courtesy ground) wires with the courtesy lamp bulb terminals installed on them into the console body, route the loose ends of those wires back up to the main console courtesy 3-way connector area (containing orange, white, and gray wires) on the dash harness and trim to length. Install terminals E on these 2 wires and then plug them into the 3-way connector A from step 2 above maintaining color continuity with the dash harness. Snap your original courtesy lamp bulb into the 2 terminals that you just installed into the console body.
- Plug the loose yellow (clock battery) wire from this kit into the 6-way connector D of this new "console extension harness, 510366" maintaining color continuity with the dash harness. Route the other end of this yellow wire down to the clock, trim to length, install terminal G and plug this wire into connector F as shown above on this instruction set. This is your clock power connection.
- Take the loose black "ground" wire from this kit and cut it in half. Double these wires together, install terminal J, and plug those wires into the open cavity of the clock power connector F from step 4 above. Route the opposite end of one of the black wires to the "floor ground" eyelet location on the forward console floor mounting bracket (just as original the was done), trim to length, install ring terminal H on this black wire, then attach it to the "floor ground" location to complete the main ground for this harness. Plug the completed connector F onto the clock assembly. Route the opposite end of the remaining black wire down to the "PRNDL" transmission indicator area, trim to length, install terminal N, and plug this wire into the open cavity on the side of lamp socket M.
- Take the two loose purple wires from this console kit and plug them into connector D of this new "console extension harness, 510366" maintaining color and function continuity (NSS and Solenoid) with the dash harness. Route the loose ends of these wires down to your console shifter, trim to length, crimp on terminals J, and plug them into connector F. Plug the completed assembly onto the neutral safety location of your neutral safety and back up lamp switch assembly.
- Take the loose light green (back up) wire from this console kit and plug them into connector D of this new "console extension harness, 510366" maintaining color continuity with the dash harness. Route the loose end of this wire down to your console shifter, trim to length, crimp on terminal G, and plug it into connector P.
- Take the loose pink (12v ign) wire from this console kit, install terminal E, and plug it into connector D of this new "console extension harness, 510366" maintaining color continuity with the dash harness. Route the loose end of this wire down to your console shifter, trim to length, crimp on terminal G, and plug it into the empty cavity of connector P (with the light green wire). Plug the completed assembly onto the back up location on your neutral safety and back up lamp switch assembly.
- Plug connectors A and D from this console kit onto the mating connectors at the dash harness to complete the console harness connection.



www.americanautowire.com 856-933-0801

console extension kit
installation instructions

1965-68 IMPALA

510366

92970260 instruction rev 0.0 3/22/2013

1966 CONSOLE CONNECTIONS WITH MANUAL TRANSMISSION ONLY

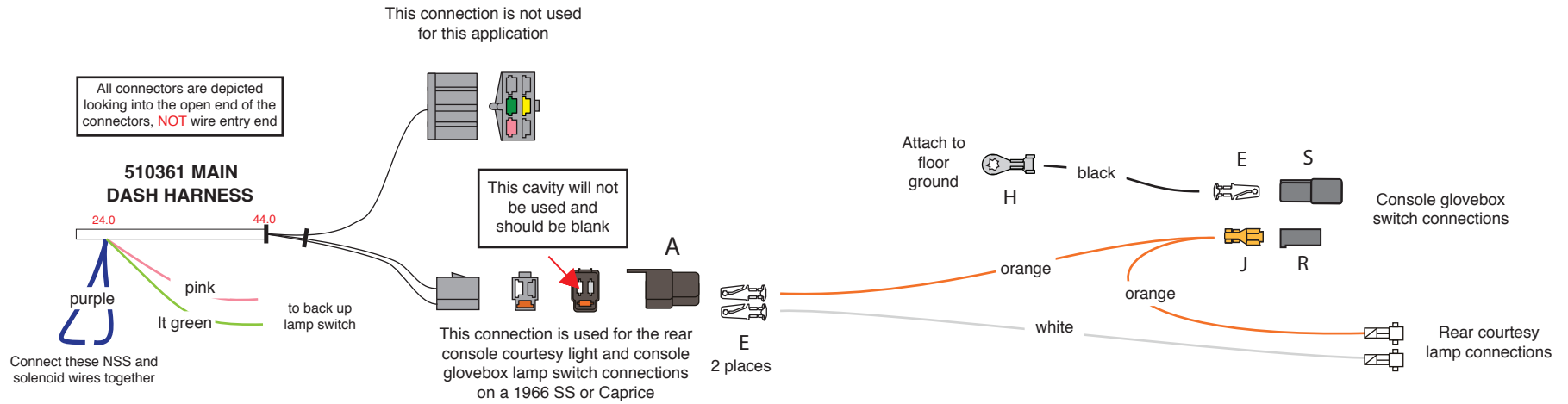

1. At branch number 6 of the main dash harness instruction set, 510361, locate items number 19 & 20. There is a 3-way connector containing orange, white, and gray wires (this is your console courtesy and console box switch connection) and a six way connector containing yellow, pink, and dark green wires (**NOTE: this connection will NOT BE USED in this application**). Locate the two heavy gauge purple wires at branch 4. These wires are your neutral safety switch wires, and they must be connected together so that the car will start. Locate the pink and light green wires at branch 4. Connect these wires to the factory back up lamp switch so that your back up lamps will operate.
2. Snap the orange (12v fused battery) and white (courtesy ground) wires with the courtesy lamp bulb terminals installed on them into the console body. Route the loose end of the white wire back up to the main console courtesy 3-way connector area (containing orange, white, and gray wires) on the dash harness and trim to length. Install terminal E on this white wire and then plug it into the 3-way connector A maintaining color continuity with the dash harness. Route the loose end of the orange wire over to the console glovebox switch area, trim to length, double it with the cutoff portion, install terminal J, and plug it into connector R as shown above. Route the loose end of the orange wire back up to the main console courtesy 3-way connector area (containing orange, white, and gray wires) on the dash harness and trim to length. Install terminal E on this orange wire and then plug it into the 3-way connector A maintaining color continuity with the dash harness. Snap your original courtesy lamp bulb into the 2 terminals that you just installed into the console body.
3. Route the black (ground) wire over to the console glovebox switch area, install terminal E, and plug it into connector S as shown above. Route the opposite end of this wire to the "floor ground" eyelet location on the forward console floor mounting bracket (just as original the was done), trim to length, install ring terminal H on this black wire, then attach it to the "floor ground" location to complete the main ground for this harness.
4. Plug connector A from this console kit onto the mating connector at the dash harness to complete the console harness connection.



www.americanautowire.com 856-933-0801

console extension kit
installation instructions

1965-68 IMPALA

510366

92970260 instruction rev 0.0 3/22/2013

1966 CONSOLE CONNECTIONS WITH MANUAL TRANSMISSION AND GAUGES

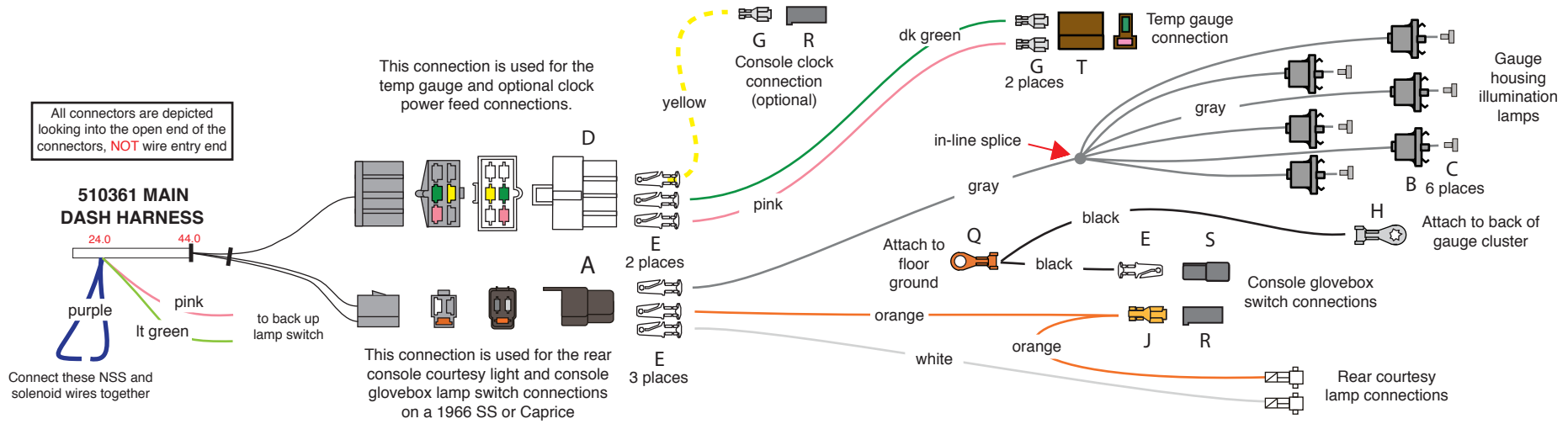

- At branch number 6 of the main dash harness instruction set, 510361, locate items number 19 & 20. There is a 3-way connector containing orange, white, and gray wires (this is your console courtesy and illumination connection) and a 6-way connector containing yellow, pink, and dark green wires (this is your gauge and clock power feed connection). Locate the two heavy gauge purple wires at branch 4. These wires are your neutral safety switch wires, and they must be connected together so that the car will start. Locate the pink and light green wires at branch 4. Connect these wires to the factory back up lamp switch so that your back up lamps will operate.
- NOTE:** It will be necessary to do an in-line splice to accommodate the (6) gauge housing illumination lamps. Crimp terminal E onto the loose gray "dash lights" wire from this kit, then plug it into the loose 3-way connector A of this new "console courtesy extension harness (510366)" maintaining color continuity with the dash harness. Route the other end of this gray wire to the console gauge housing area and trim to length. Take the remaining portion of this gray wire and make six, 6 to 8-inch pigtail wires. Crimp rivet C onto each of the six pigtail wires, then slide one lamp socket B onto each of the six wires. Splice the six completed pigtail wires with the lamp sockets on them to the main lead wire that you had already plugged into the 3-way connector A. It is recommended that the splice joint should be soldered. Be sure to insulate the spliced joint with shrink tubing or by some other means.
- Snap the orange (12v fused battery) and white (courtesy ground) wires with the courtesy lamp bulb terminals installed on them into the console body. Route the loose end of the white wire back up to the main console courtesy 3-way connector area (containing orange, white, and gray wires) on the dash harness and trim to length. Install terminal E on this white wire and then plug it into the 3-way connector A maintaining color continuity with the dash harness. Route the loose end of the orange wire over to the console glovebox switch area, trim to length, double it with the cutoff portion, install terminal J, and plug it into connector R as shown above. Route the loose end of the orange wire back up to the main console courtesy 3-way connector area (containing orange, white, and gray wires) on the dash harness and trim to length. Install terminal E on this orange wire and then plug it into the 3-way connector A maintaining color continuity with the dash harness. Snap your original courtesy lamp bulb into the 2 terminals that you just installed into the console body.
- If your car is equipped with the rare console clock in the upper RH quadrant, plug the loose yellow (clock battery) wire from this kit into the 6-way connector D of this new "console extension harness, 510366" maintaining color continuity with the dash harness. Route the other end of this yellow wire over to the clock, trim to length, install terminal G and plug this wire into connector R as shown above on this instruction set. This is your clock power connection.
- Route the black (ground) wire over to the console glovebox switch area, install terminal E, and plug it into connector S as shown above. Route the opposite end of this wire to the "floor ground" eyelet location on the forward console floor mounting bracket (just as original the was done), trim to length, double it with the cutoff portion and install ring terminal Q. Route the remaining portion of this black wire up to the back of the console gauge cluster, trim to length, install terminal H and attach it to the back of the console gauge cluster. Once completed, attach double wires with terminal Q crimped on them to the "floor ground" location to complete the main ground for this harness.
- Take the loose dark green (temp) and pink (fused 12v ign) wires from this console kit, install terminals E, and plug them into connector D of this new "console extension harness, 510366" maintaining color continuity with the dash harness. Route the loose ends of these wires over to the console temperature gauge area, trim to length, crimp on terminals G, and plug them into connector T as shown above. Plug the completed assembly onto your temperature gauge.
- Plug connectors A and D from this console kit onto the mating connectors at the dash harness to complete the console harness connection.

NOTE: Your new AAW kit **DOES NOT** support the use of a factory ammeter. AAW suggests the use of a voltmeter as a better way of monitoring your charging system.



www.americanautowire.com 856-933-0801

console extension kit
installation instructions

1965-68 IMPALA

510366

92970260 instruction rev 0.0 3/22/2013

1966 CONSOLE CONNECTIONS WITH AUTOMATIC TRANSMISSION ONLY

All connectors are depicted looking into the open end of the connectors, **NOT** wire entry end

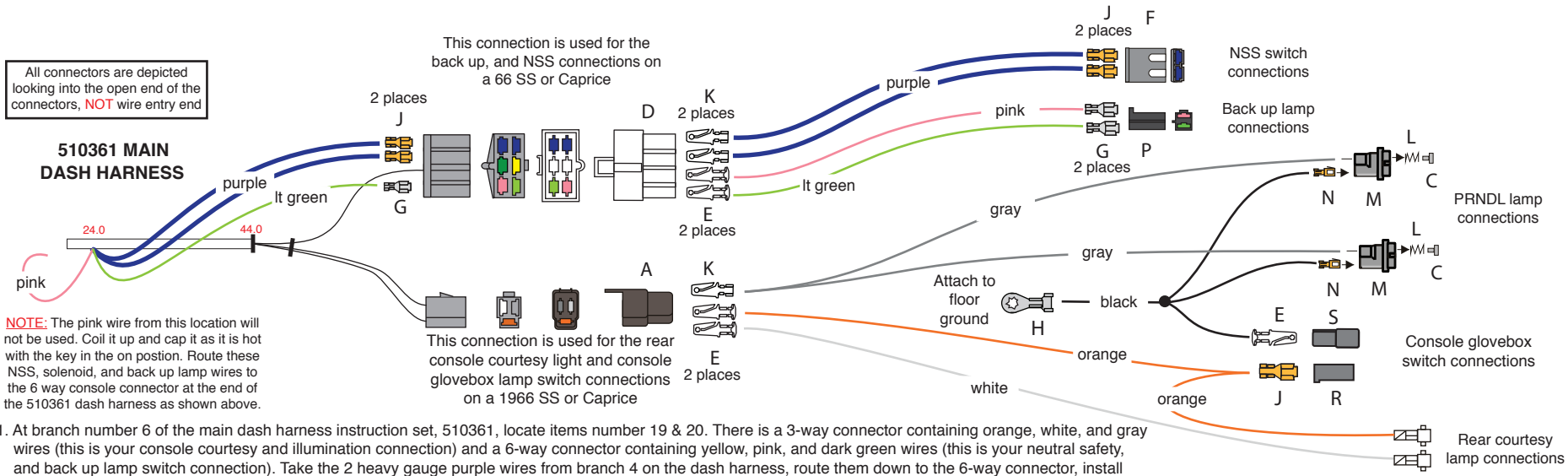

NOTE: The pink wire from this location will not be used. Coil it up and cap it as it is hot with the key in the on position. Route these NSS, solenoid, and back up lamp wires to the 6 way console connector at the end of the 510361 dash harness as shown above.

- At branch number 6 of the main dash harness instruction set, 510361, locate items number 19 & 20. There is a 3-way connector containing orange, white, and gray wires (this is your console courtesy and illumination connection) and a 6-way connector containing yellow, pink, and dark green wires (this is your neutral safety, and back up lamp connection). Take the 2 heavy gauge purple wires from branch 4 on the dash harness, route them down to the 6-way connector, install terminals J, and plug them into the 6-way connector as shown above. They can install into either of the 2 cavities shown, as no indexing is required. Take the light green wire from branch 4 on the dash harness, route it down to the 6-way connector, install terminal G, and plug it into the empty cavity on the 6-way connector as shown above. The pink wire at branch 4 will not be used and must be coiled up and capped, as it is hot when the key is in the "ON" position.
- Take the loose gray "dash lights" wire from this kit and cut it in half. Double these wires together, install terminal K, and plug those wires into the loose 3-way connector A of this new "console courtesy extension harness (510366)" maintaining color continuity with the dash harness. Route each of the gray wires down to the "PRNDL" transmission indicator area, trim to length, install lamp socket M and spring L on each of the wires, then crimp rivet C onto each of the wires.
- Snap the orange (12v fused battery) and white (courtesy ground) wires with the courtesy lamp bulb terminals installed on them into the console body. Route the loose end of the white wire back up to the main console courtesy 3-way connector area (containing orange, white, and gray wires) on the dash harness and trim to length. Install terminal E on this white wire and then plug it into the 3-way connector A maintaining color continuity with the dash harness. Route the loose end of the orange wire over to the console glovebox switch area, trim to length, double it with the cutoff portion, install terminal J, and plug it into connector R as shown above. Route the loose end of the orange wire back up to the main console courtesy 3-way connector area (containing orange, white, and gray wires) on the dash harness and trim to length. Install terminal E on this orange wire and then plug it into the 3-way connector A maintaining color continuity with the dash harness. Snap your original courtesy lamp bulb into the 2 terminals that you just installed into the console body.
- NOTE:** There are 2 options on the black (ground) wires. Option one (shown above) involves doing an in-line splice. Option two (shown at the right) involves doing a daisy-chain style connection.

Option 1: Take the loose black "ground" wire from this kit and cut (2) 20-inch wires and a 10-inch wire from it. Take one of the 20-inch wires and the 10-inch wire and install terminal N. Take the other 20-inch wire and install terminal E and plug that wire into connector S. Take the remaining portion of the black (ground) wire, cut a 60-inch piece from it, and install ring terminal H on one end. Take the loose end of the long wire with the ring terminal and splice it to the other 3 wires. We recommend that the splice joint should be soldered. Be sure to insulate the spliced joint with shrink tubing or by some other means. Plug the two terminals N into the open cavity on each of the side of lamp sockets M as shown above. When you have completed the building of your console harness, attach the ring terminal to the "floor ground" location to complete the main ground for this harness.

Option 2: Take the loose black "ground" wire from this kit and install terminal N on it. Measure out 65-inches and cut the wire. Double that wire together with the remaining portion and install ring terminal Q (solder this connection). From the ring terminal, measure out 77-inches and cut the wire. Double that wire together with the remaining portion, install terminal K (solder this connection), and plug these wires into connector S. From the end of connector S, measure out 12-inches, cut the wire, and install terminal N. Plug the two terminals N into the open cavity on the side of lamp sockets M as shown to the right. When you have completed the building of your console harness, attach the ring terminal to the "floor ground" location to complete the main ground for this harness.
- Take the two loose purple wires from this console kit and plug them into connector D of this new "console extension harness, 510366" maintaining **color and function** continuity (NSS and Solenoid) with the dash harness. Route the loose ends of these wires down to your console shifter, trim to length, crimp on terminals J, and plug them into connector F. Plug the completed assembly onto the neutral safety location of the neutral safety and back up lamp switch assembly.
- Take the loose light green (back up) wire from this console kit and plug it into connector D of this new "console extension harness, 510366" maintaining color continuity with the dash harness. Route the loose end of this wire down to your console shifter, trim to length, crimp on terminal G, and plug it into connector P.
- Take the loose pink (12v ign) wire from this console kit, install terminal E, and plug it into connector D of this new "console extension harness, 510366" maintaining color continuity with the dash harness. Route the loose end of this wire down to your console shifter, trim to length, crimp on terminal G, and plug it into the empty cavity of connector P (with the light green wire). Plug the completed assembly onto the back up location on your neutral safety and back up lamp switch assembly.
- Plug connectors A and D from this console kit onto the mating connectors at the dash harness to complete the console harness connection.

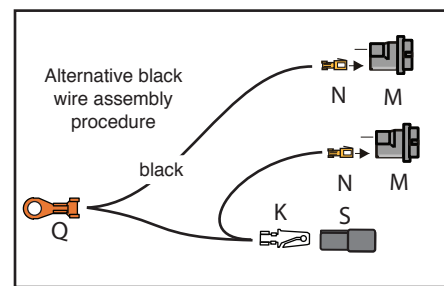

www.americanautowire.com 856-933-0801

console extension kit
installation instructions
1965-68 IMPALA
510366
92970260 instruction rev 0.0 3/22/2013

1966 CONSOLE CONNECTIONS WITH AUTOMATIC TRANSMISSION AND GAUGES

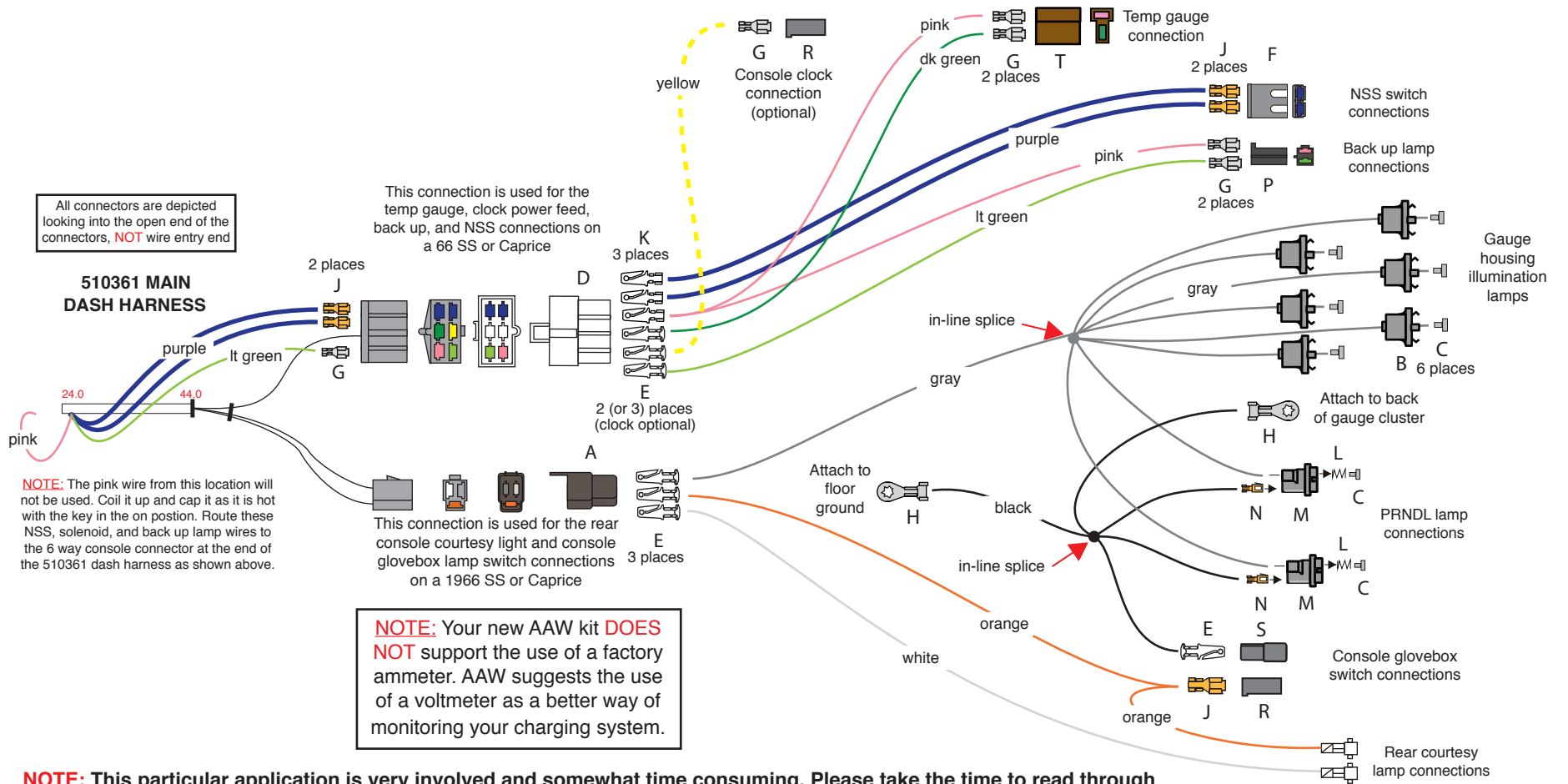

NOTE: This particular application is very involved and somewhat time consuming. Please take the time to read through the assembly directions on pages 7 and 8 thoroughly before attempting to assemble this kit. It will be necessary to do an in-line splice for the gray and black wires due to the number of connections that must be made for these circuits. We suggest that the splices should be crimped and soldered, and the splice insulated with shrink tubing or by other means.

- At branch number 6 of the main dash harness instruction set, 510361, locate items number 19 & 20. There is a 3-way connector containing orange, white, and gray wires (this is your console courtesy and illumination connection) and a six way connector containing yellow, pink, and dark green wires (these are your temp gauge, clock power feed, neutral safety, and back up lamp switch connections). Take the 2 heavy gauge purple wires from branch 4 on the dash harness, route them down to the 6-way connector, install terminals J, and plug them into the 6-way connector as shown above. They can install into either of the 2 cavities shown, as no indexing is required. Take the light green wire from branch 4 on the dash harness, route it down to the 6-way connector, install terminal G, and plug it into the empty cavity on the 6-way connector as shown above. The pink wire at branch 4 will not be used and must be coiled up and capped, as it is hot when the key is in the "ON" position.

- NOTE:** It will be necessary to do an in-line splice to accommodate the six gauge housing and the two PRNDL transmission selector illumination lamps.

Crimp terminal E onto the loose gray "dash lights" wire from this kit, then plug it into the loose 3-way connector A of this new "console courtesy extension harness (510366)" maintaining color continuity with the dash harness. Route the other end of this gray wire to the console gauge housing area and trim to length. Take the remaining portion of this gray wire and make six, 6 to 8 inch pigtail wires to accommodate the gauge housing illumination lamps. Crimp rivet C onto each of the six pigtail wires, then slide one lamp socket B onto each of the six wires. Next, take the remaining portion of the gray wire and cut a 36-inch pigtail wire and a 48-inch pigtail wire to accommodate the two PRNDL transmission selector illumination lamps. Crimp rivet C onto each of the two pigtail wires, slide one lamp socket M and then one lamp socket spring L onto each of the two wires. Splice the eight completed pigtail wires with the lamp sockets on them to the main lead wire that you had already plugged into the 3-way connector A. It is recommended that the splice joint should be soldered. Be sure to insulate the spliced joint with shrink tubing or by some other means as well.



www.americanautowire.com 856-933-0801

console extension kit
installation instructions
1965-68 IMPALA
510366
92970260 instruction rev 0.0 3/22/2013

1966 CONSOLE CONNECTIONS WITH AUTOMATIC TRANSMISSION AND GAUGES

continued from sheet 7

3. Snap the orange (12v fused battery) and white (courtesy ground) wires with the courtesy lamp bulb terminals installed on them into the console body. Route the loose end of the white wire back up to the main console courtesy 3-way connector area (containing orange, white, and gray wires) on the dash harness and trim to length. Install terminal E on this white wire and then plug it into the 3-way connector A maintaining color continuity with the dash harness. Route the loose end of the orange wire over to the console glovebox switch area, trim to length, double it with the cutoff portion, install terminal J, and plug it into connector R as shown on sheet 7. Route the loose end of the orange wire back up to the main console courtesy 3-way connector area (containing orange, white, and gray wires) on the dash harness and trim to length. Install terminal E on this orange wire and then plug it into the 3-way connector A maintaining color continuity with the dash harness. Snap your original courtesy lamp bulb into the 2 terminals that you just installed into the console body.
4. If your car is equipped with the rare console clock in the upper RH quadrant, plug the loose yellow (clock battery) wire from this kit into the 6-way connector D of this new "console extension harness, 510366" maintaining color continuity with the dash harness. Route the other end of this yellow wire over to the clock, trim to length, install terminal G and plug this wire into connector R as shown above on this instruction set. This is your clock power connection.
5. **NOTE:** It will be necessary to do an in-line splice to accommodate console glovebox lamp switch ground connection, the console gauge cluster ground connection and the two PRNDL transmission selector illumination lamp grounds.

Take the loose black "ground" wire from this kit and cut (2) 20-inch wires and a 10-inch wire from it. Take one of the 20-inch wires and the 10-inch wire and install terminal N. Take the other 20-inch wire and install terminal E and plug that wire into connector S. Take the remaining portion of the black (ground) wire, cut a 16 inch piece from it, and install ring terminal H on one end. Take the remaining portion of the black (ground) wire, cut a 24 inch piece from it, and install ring terminal H on one end. Take the loose ends of the (2) wires with the ring terminals installed on them and splice them to the other 3 wires. We recommend that the splice joint should be soldered. Be sure to insulate the spliced joint with shrink tubing or by some other means. Plug the two terminals N into the open cavity on the side of each of the two lamp sockets M as shown above. Route the longer wire with the ring terminal on it up to the console gauge cluster and attach it to the back of the cluster. Attach the shorter wire with the ring terminal on it to the "floor ground" location to complete the main ground for this harness.

6. Take the two loose purple wires from this console kit, install terminals K on each wire, and plug them into connector D of this new "console extension harness, 510366" maintaining **color and function** continuity (NSS and Solenoid) with the dash harness. Route the loose ends of these wires down to your console shifter, trim to length, crimp on terminals J, and plug them into connector F. Plug the completed assembly onto the "neutral safety" location of your neutral safety/back up lamp switch assembly inside the console.
7. Take the loose light green (back up) wire from this console kit, install terminal E, and plug it into connector D of this new "console extension harness, 510366" maintaining color continuity with the dash harness. Route the loose end of this wire down to your console shifter, trim to length, crimp on terminal G, and plug it into connector P as shown on page 7.
8. Take the loose dark green (temp) wire from this console kit, install terminal E, and plug it into connector D of this new "console extension harness, 510366" maintaining color continuity with the dash harness. Route the loose end of this wire over to the console temperature gauge area, trim to length, crimp on terminal G, and plug it into connector T as shown on page 7.
9. Take the loose pink (12v ign) wire from this kit and cut it in half. Double these wires together, install terminal K, and plug those wires into connector D of this new "console extension harness (510366)" maintaining color continuity with the dash harness. Route the loose end of one of the pink wires down to your console shifter, trim to length, crimp on terminal G, and plug it into connector P (with the lt green wire from step 7) as shown on page 7. Route the loose end of the other pink wire over to the console temperature gauge area, trim to length, crimp on terminal G, and plug it into connector T (with the dk green wire from step 8) as shown on page. Plug the completed connector P onto the "back up" location of your neutral safety/back up switch assembly inside the console. Plug the completed connector T onto your temperature gauge assembly in the console gauge cluster.
10. Plug connectors A and D from this console kit onto the mating connectors at the dash harness to complete the console harness connection.



www.americanautowire.com 856-933-0801

console extension kit
installation instructions

1965-68 IMPALA

510366

92970260 instruction rev 0.0 3/22/2013

1967-68 CONSOLE CONNECTIONS WITH MANUAL TRANSMISSION

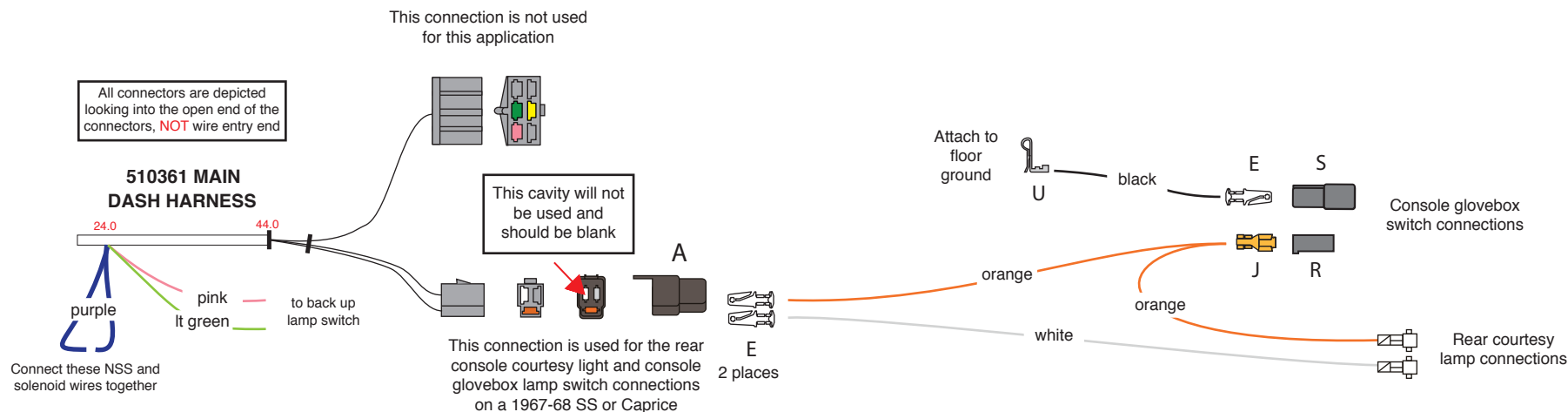

1. At branch number 6 of the main dash harness instruction set, 510361, locate items number 19 & 20. There is a 3-way connector containing orange, white, and gray wires (this is your console courtesy and console box switch connection) and a six way connector containing yellow, pink, and dark green wires (**NOTE: this connection will NOT BE USED** in this application). Locate the two heavy gauge purple wires at branch 4. These wires are your neutral safety switch wires, and they must be connected together so that the car will start. Locate the pink and light green wires at branch 4. Connect these wires to the factory back up lamp switch so that your back up lamps will operate.
2. Snap the orange (12v fused battery) and white (courtesy ground) wires with the courtesy lamp bulb terminals installed on them into the console body. Route the loose end of the white wire back up to the main console courtesy 3-way connector area (containing orange, white, and gray wires) on the dash harness and trim to length. Install terminal E on this white wire and then plug it into the 3-way connector A maintaining color continuity with the dash harness. Route the loose end of the orange wire over to the console glovebox switch area, trim to length, double it with the cutoff portion, install terminal J, and plug it into connector R as shown above. Route the loose end of the orange wire back up to the main console courtesy 3-way connector area (containing orange, white, and gray wires) on the dash harness and trim to length. Install terminal E on this orange wire and then plug it into the 3-way connector A maintaining color continuity with the dash harness. Snap your original courtesy lamp bulb into the 2 terminals that you just installed into the console body.
3. Route the black (ground) wire over to the console glovebox switch area, install terminal E, and plug it into connector S as shown above. Route the opposite end of this wire to the "floor ground" location on the forward console floor mounting bracket (just as original the was done), trim to length, install terminal U on this black wire, then slide it onto the "floor ground" location to complete the main ground for this harness.
4. Plug connector A from this console kit onto the mating connector at the dash harness to complete the console harness connection.



www.americanautowire.com 856-933-0801

console extension kit
installation instructions

1965-68 IMPALA

510366

92970260 instruction rev 0.0 3/22/2013

1967 CONSOLE CONNECTIONS WITH AUTOMATIC TRANSMISSION

Classic Update Series

All connectors are depicted looking into the open end of the connectors, NOT wire entry end

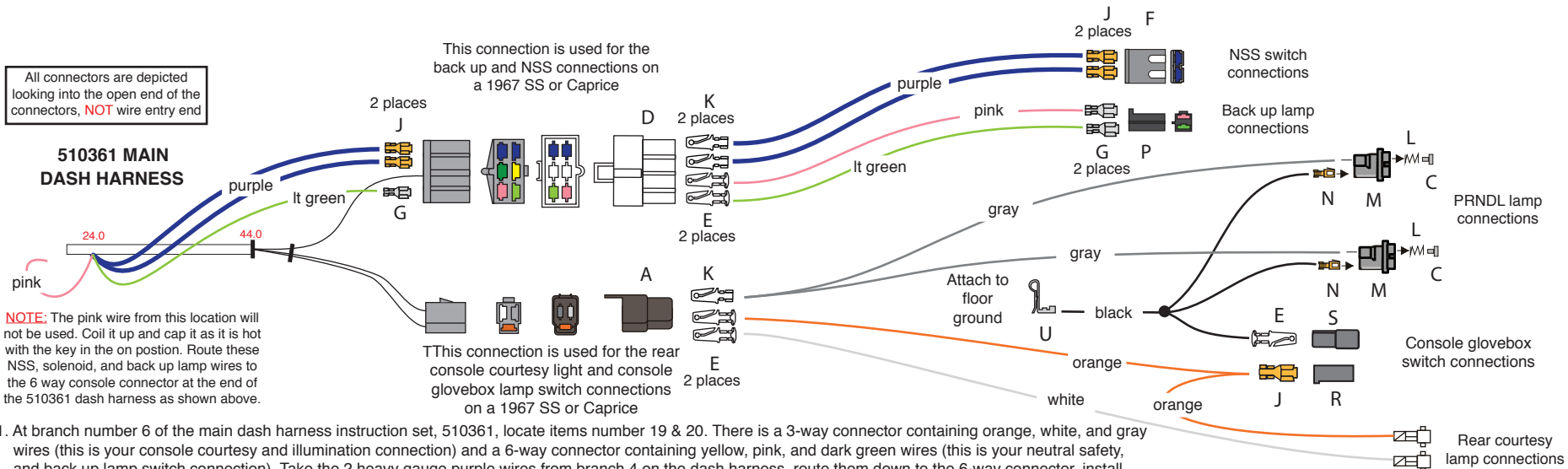

NOTE: The pink wire from this location will not be used. Coil it up and cap it as it is hot with the key in the on position. Route these NSS, solenoid, and back up lamp wires to the 6 way console connector at the end of the 510361 dash harness as shown above.

- At branch number 6 of the main dash harness instruction set, 510361, locate items number 19 & 20. There is a 3-way connector containing orange, white, and gray wires (this is your console courtesy and illumination connection) and a 6-way connector containing yellow, pink, and dark green wires (this is your neutral safety, and back up lamp connection). Take the 2 heavy gauge purple wires from branch 4 on the dash harness, route them down to the 6-way connector, install terminals J, and plug them into the 6-way connector as shown above. They can install into either of the 2 cavities shown, as no indexing is required. Take the light green wire from branch 4 on the dash harness, route it down to the 6-way connector, install terminal G, and plug it into the empty cavity on the 6-way connector as shown above. The pink wire at branch 4 will not be used and must be coiled up and capped, as it is hot when the key is in the "ON" position.
- Take the loose gray "dash lights" wire from this kit and cut it in half. Double these wires together, install terminal K, and plug those wires into the loose 3-way connector A of this new "console courtesy extension harness (510366)" maintaining color continuity with the dash harness. Route each of the gray wires down to the "PRNDL" transmission indicator area, trim to length, install lamp socket M and spring L on each of the wires, then crimp rivet C onto each of the wires.
- Snap the orange (12v fused battery) and white (courtesy ground) wires with the courtesy lamp bulb terminals installed on them into the console body. Route the loose end of the white wire back up to the main console courtesy 3-way connector area (containing orange, white, and gray wires) on the dash harness and trim to length. Install terminal E on this white wire and then plug it into the 3-way connector A maintaining color continuity with the dash harness. Route the loose end of the orange wire over to the console glovebox switch area, trim to length, double it with the cutoff portion, install terminal J, and plug it into connector R as shown above. Route the loose end of the orange wire back up to the main console courtesy 3-way connector area (containing orange, white, and gray wires) on the dash harness and trim to length. Install terminal E on this orange wire and then plug it into the 3-way connector A maintaining color continuity with the dash harness. Snap your original courtesy lamp bulb into the 2 terminals that you just installed into the console body.
- NOTE:** There are 2 options on the black (ground) wires. Option one (shown above) involves doing an in-line splice. Option two (shown at the right) involves doing a daisy-chain style connection.

Option 1: Take the loose black "ground" wire from this kit and cut (2) 20-inch wires and a 10-inch wire from it. Take one of the 20-inch wires and the 10-inch wire and install terminal N. Take the other 20-inch wire and install terminal E and plug that wire into connector S. Take the remaining portion of the black (ground) wire, cut a 30-inch piece from it, and install terminal U on one end. Take the loose end of the long wire with terminal U on it and splice it to the other 3 wires. We recommend that the splice joint should be soldered. Be sure to insulate the spliced joint with shrink tubing or by some other means. Plug the two terminals N into the open cavity on the side of lamp sockets M as shown to the right. When you have completed the building of your console harness, slide terminal U onto the "floor ground" location to complete the main ground for this harness.

Option 2: Take the loose black "ground" wire from this kit and install terminal N on it. Measure out 30-inches and cut the wire. Double that wire together with the remaining portion and install terminal U (solder this connection). From terminal U, measure out 42-inches and cut the wire. Double that wire together with the remaining portion, install terminal K (solder this connection), and plug these wires into connector S. From the end of connector S, measure out 12-inches, cut the wire, and install terminal N. Plug the two terminals N into the open cavity on the side of lamp sockets M as shown to the right. When you have completed the building of your console harness, slide terminal U onto the "floor ground" location to complete the main ground for this harness.
- Take the two loose purple wires from this console kit and plug them into connector D of this new "console extension harness, 510366" maintaining **color and function** continuity (NSS and Solenoid) with the dash harness. Route the loose ends of these wires down to your console shifter, trim to length, crimp on terminals J, and plug them into connector F. Plug the completed assembly onto the neutral safety location of the neutral safety and back up lamp switch assembly.
- Take the loose light green (back up) wire from this console kit and plug it into connector D of this new "console extension harness, 510366" maintaining color continuity with the dash harness. Route the loose end of this wire down to your console shifter, trim to length, crimp on terminal G, and plug it into connector P.
- Take the loose pink (12v ign) wire from this console kit, install terminal E, and plug it into connector D of this new "console extension harness, 510366" maintaining color continuity with the dash harness. Route the loose end of this wire down to your console shifter, trim to length, crimp on terminal G, and plug it into the empty cavity of connector P (with the light green wire). Plug the completed assembly onto the back up location on your neutral safety and back up lamp switch assembly.
- Plug connectors A and D from this console kit onto the mating connectors at the dash harness to complete the console harness connection.

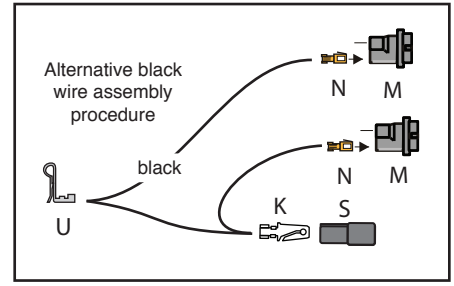

www.americanautowire.com 856-933-0801

console extension kit
installation instructions
1965-68 IMPALA
510366
92970260 instruction rev 0.0 3/22/2013

1968 CONSOLE CONNECTIONS WITH AUTOMATIC TRANSMISSION

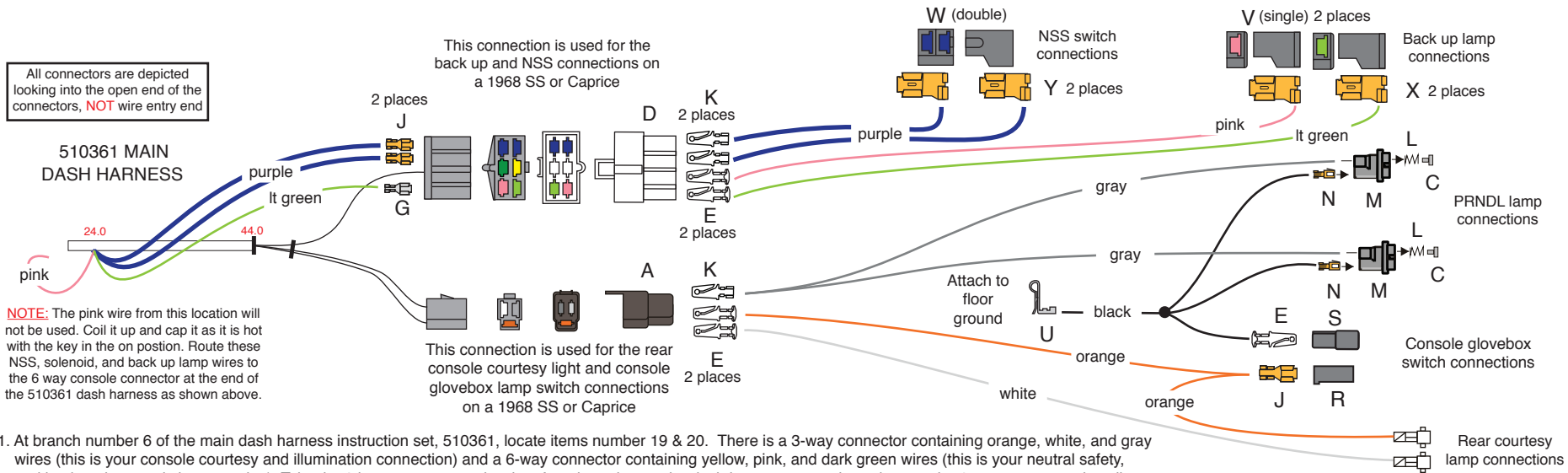

- At branch number 6 of the main dash harness instruction set, 510361, locate items number 19 & 20. There is a 3-way connector containing orange, white, and gray wires (this is your console courtesy and illumination connection) and a 6-way connector containing yellow, pink, and dark green wires (this is your neutral safety, and back up lamp switch connection). Take the 2 heavy gauge purple wires from branch 4 on the dash harness, route them down to the 6-way connector, install terminals J, and plug them into the 6-way connector as shown above. Take the light green wire from branch 4 on the dash harness, route it down to the 6-way connector, install terminal G, and plug it into the empty cavity on the 6-way connector as shown above. The pink wire at branch 4 will not be used and must be coiled up and capped, as it is hot when the key is in the "ON" position.
- Take the loose gray "dash lights" wire from this kit and cut it in half. Double these wires together, install terminal K, and plug those wires into the loose 3-way connector A of this new "console courtesy extension harness (510366)" maintaining color continuity with the dash harness. Route each of the gray wires down to the "PRNDL" transmission indicator area, trim to length, install lamp socket M and spring L on each of the wires, then crimp rivet C onto each of the wires.
- Snap the orange (12v fused battery) and white (courtesy ground) wires with the courtesy lamp bulb terminals installed on them into the console body. Route the loose end of the white wire back up to the main console courtesy 3-way connector area (containing orange, white, and gray wires) on the dash harness and trim to length. Install terminal E on this white wire and then plug it into the 3-way connector A maintaining color continuity with the dash harness. Route the loose end of the orange wire over to the console glovebox switch area, trim to length, double it with the cutoff portion, install terminal J, and plug it into connector R as shown above. Route the loose end of the orange wire back up to the main console courtesy 3-way connector area (containing orange, white, and gray wires) on the dash harness and trim to length. Install terminal E on this orange wire and then plug it into the 3-way connector A maintaining color continuity with the dash harness. Snap your original courtesy lamp bulb into the 2 terminals that you just installed into the console body.
- NOTE:** There are 2 options on the black (ground) wires. Option one (shown above) involves doing an in-line splice. Option two (shown at the right) involves doing a daisy-chain style connection.

Option 1: Take the loose black "ground" wire from this kit and cut a 24-inch wire, a 12-inch wire, and a 21-inch wire from it. Install terminal N onto the 24-inch wire and the 12-inch wire. Install terminal E onto the 21-inch wire and plug that wire into connector S. Take the remaining portion of the black (ground) wire, cut a 30-inch piece from it, and install terminal U on one end. Take the loose end of the wire with the terminal U on it and splice it to the other 3 wires. We recommend that the splice joint should be soldered. Be sure to insulate the spliced joint with shrink tubing or by some other means. Plug the two terminals N into the open cavity on the side of lamp sockets M as shown on above. When you have completed the building of your console harness, slide terminal U onto the "floor ground" location to complete the main ground for this harness.

Option 2: Take the loose black "ground" wire from this kit and install terminal N on it. Measure out 40-inches and cut the wire. Double that wire together with the remaining portion and install terminal U (solder this connection). From terminal U, measure out 48-inches and cut the wire. Double that wire together with the remaining portion, install terminal K (solder this connection), and plug these wires into connector S. From the end of connector S, measure out 18-inches, cut the wire, and install terminal N. Plug the two terminals N into the open cavity on the side of lamp sockets M as shown to the right. When you have completed the building of your console harness, slide terminal U onto the "floor ground" location to complete the main ground for this harness.
- Take the two loose purple wires from this console kit and plug them into connector D of this new "console extension harness, 510366" maintaining **color and function** continuity (NSS and Solenoid) with the dash harness. Route the loose ends of these wires down to your console shifter, trim to length, crimp on terminals W (solder these connections), and plug them into connector W. Plug the completed assembly onto the neutral safety location of the neutral safety and back up lamp switch assembly.
- Take the loose light green (back up) wire from this console kit and plug it into connector D of this new "console extension harness, 510366" maintaining color continuity with the dash harness. Route the loose end of this wire down to your console shifter, trim to length, crimp on terminal X (solder this connection), and plug it into connector V. Plug the completed assembly onto one of the back up blades on your neutral safety and back up lamp switch assembly.
- Take the loose pink (12v ign) wire from this console kit, install terminal E, and plug it into connector D of this new "console extension harness, 510366" maintaining color continuity with the dash harness. Route the loose end of this wire down to your console shifter, trim to length, crimp on terminal X (solder this connection), and plug it into connector V. Plug the completed assembly onto one of the back up blades on your neutral safety and back up lamp switch assembly.
- Plug connectors A and D from this console kit onto the mating connectors at the dash harness to complete the console harness connection.

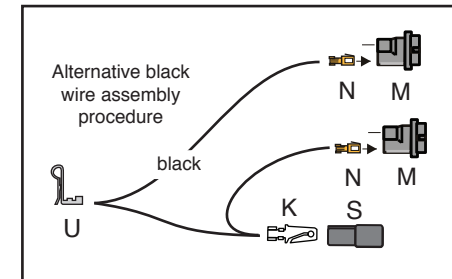

www.americanautowire.com 856-933-0801

console extension kit
installation instructions

1965-68 IMPALA

510366

92970260 instruction rev 0.0 3/22/2013

THIS PAGE HAS
INTENTIONALLY
BEEN LEFT BLANK



www.americanautowire.com 856-933-0801

console extension kit
installation instructions

1965-68 IMPALA

510366

92970260 instruction rev 0.0 3/22/2013

Classic Update Series

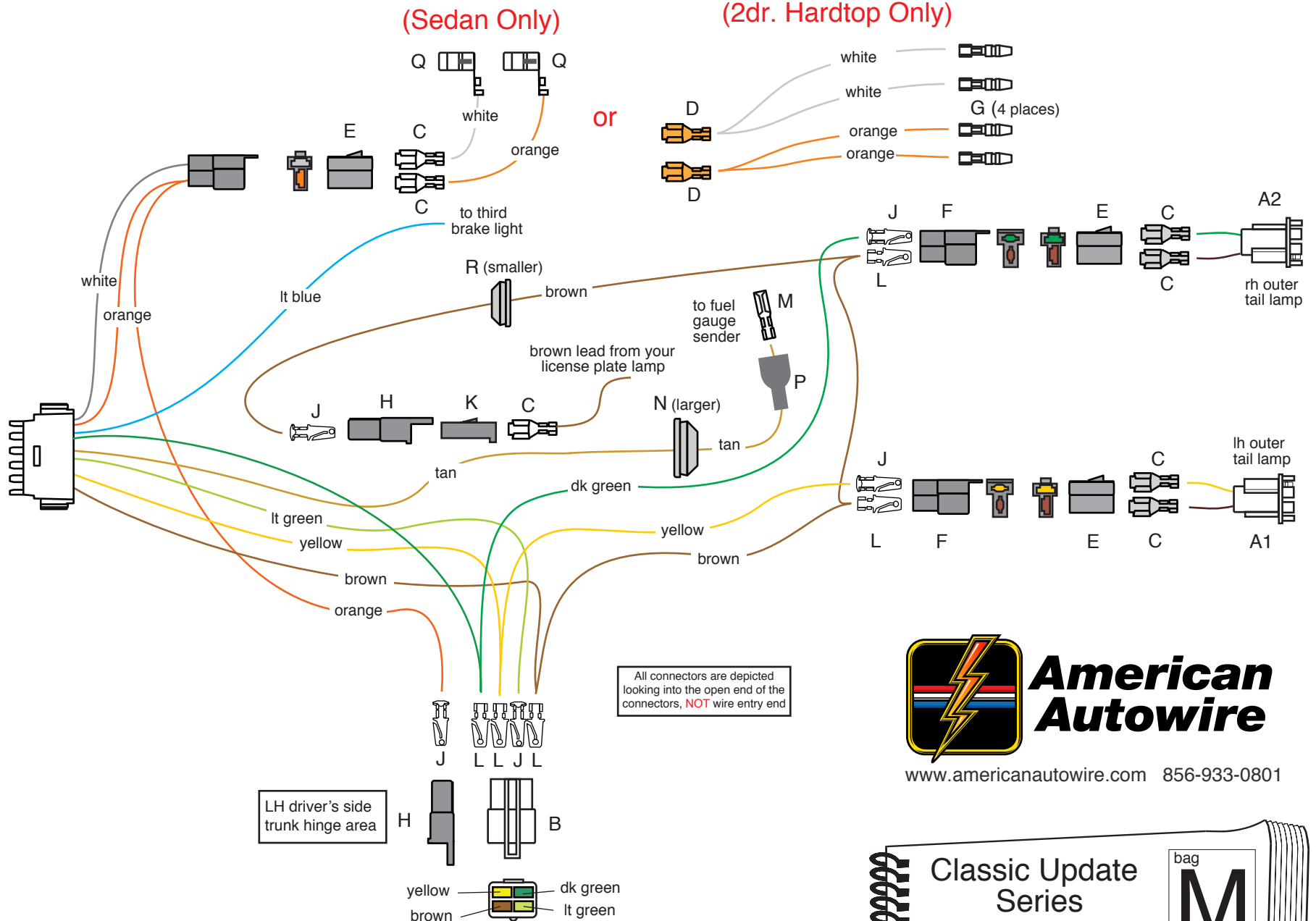

USE THIS SHEET FOR A
65 Impala, Bel Air or Biscayne

On any of the 1965 models,
your trunk lid harness, 510367,
Bag P, will plug in here.



**American
Autowire**

www.americanautowire.com 856-933-0801

Classic Update Series bag M
65-68 Chevy Impala
REAR BODY KIT
510365
92970256 instruction rev 0.0 4/9/2013

USE THIS SHEET FOR A 65 IMPALA, BEL AIR, BISCAYNE



Connect the main connector on this harness to the mating connector on the dash harness, 510361, bag G. Route this harness down along the LH driver's side door sill and back into trunk.



LIGHT BLUE Third brake light Connect to the third brake lamp, if equipped.

TAN Gas gauge Route this tan wire to the rear of the car, down thru access hole in trunk floor to the fuel sending unit, and cut to length. Slide grommet N onto this wire in the direction shown on sheet 1, then slide boot P onto this wire in the direction shown on sheet 1, and install terminal M onto the wire. Pull boot P up over terminal M and then attach this assembled wire onto the fuel sending unit.



BROWN Rear running lights Route this brown wire to the LH driver's side trunk hinge area, trim to length, double it with the cut off portion, install terminal L, and plug into connector B as shown on sheet 1. Route the loose end of this brown wire to the left side tail light area, trim to length, double it with the cut off portion, install terminal L and plug into connector F as shown on sheet 1. Route the loose end of this brown wire to the right side tail light area, trim to length, double it with the cut off portion, install terminal L and plug into connector F as shown on sheet 1. Route the remaining portion of this brown wire to the license plate lamp area, trim to length, slide grommet R onto this wire in the direction shown on sheet 1, install terminal J, and plug into connector H as shown on sheet 1. New terminal C and connector K have been provided for you to install onto your original license plate lamp lead. Plug your re-terminated license plate lamp lead (not included) into connector H as shown on sheet 1.



NOTE: You have been provided with tail lamp socket pigtails for the LH (A1) and RH (A2) sides of the car. Install terminals C and plug the brown, yellow, and dark green leads into connector E as shown on sheet 1.



YELLOW Left rear turn Route this yellow wire to the LH driver's side trunk hinge area, trim to length, double it with the cut off portion, install terminal L, and plug into connector B as shown on sheet 1. Route the loose end of this yellow wire to the left side tail light area, trim to length, install terminal J and plug into the empty cavity of connector F as shown on sheet 1. Plug pigtail A1 into this connection to complete your LH tail lamp circuit.



DK GREEN Right rear turn Route this dark green wire to the LH driver's side trunk hinge area, trim to length, double it with the cut off portion, install terminal L, and plug into connector B as shown on sheet 1. Route the loose end of this dark green wire to the right side tail light area, trim to length, install terminal J and plug into the empty cavity of connector F as shown on sheet 1. Plug pigtail A2 into this connection to complete your RH tail lamp circuit.



LT GREEN Back up lt sw Route this light green wire to the LH driver's side trunk hinge area, trim to length, install terminal J, and plug into connector B as shown on sheet 1.



Note: There is a 2 way male connector directly off of the main connector. Your completed dome lamp harness will plug in there. Route the loose end of the orange wire doubled into this 2 way male connector to the LH driver's side trunk hinge area, trim to length, install terminal J, and plug into connector H as shown on sheet 1. Your factory trunk lamp (not included) will plug into this connection if your car has that option.

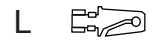

WHITE Ctsy ground (Sedan models) Install terminal Q onto the loose piece white wire and snap it into your dome lamp base. Route the loose end of this wire down the windshield pillar to the 2-way connector in the driver's kick panel area containing the orange and white wires, trim to length, install terminal C and plug into connector E as shown on sheet 1.



(Sport coupe models) Install terminal G onto the loose piece white wire and snap it into your LH rear sail panel lamp. Route the loose end of this wire down the LH windshield pillar to the 2-way connector in the driver's kick panel area containing the orange and white wires, and trim to length. Install terminal G onto the remaining portion of the white wire and snap it into your RH rear sail panel lamp. Route the loose end of this wire across the roof, then down the LH windshield pillar to the 2-way connector in the driver's kick panel area containing the orange and white wires and trim to length. Double the two white wires together, install terminal D and plug into connector E as shown on sheet 1.













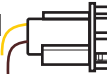
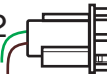

ORANGE 12v battery - fused (Sedan models) Install terminal Q onto the loose piece orange wire and snap it into your dome lamp base. Route the loose end of this wire down the windshield pillar to the 2-way connector in the driver's kick panel area containing the orange and white wires, trim to length, install terminal C and plug into connector E as shown on sheet 1.



(Sport coupe models) Install terminal G onto the loose piece orange wire and snap it into your LH rear sail panel lamp. Route the loose end of this wire down the LH windshield pillar to the 2-way connector in the driver's kick panel area containing the orange and white wires, and trim to length. Install terminal G onto the remaining portion of the orange wire and snap it into your RH rear sail panel lamp. Route the loose end of this wire across the roof, then down the LH windshield pillar to the 2-way connector in the driver's kick panel area containing the orange and white wires and trim to length. Double the two orange wires together, install terminal D and plug into connector E as shown on sheet 1.

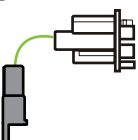

USE THIS SHEET FOR A 66 BEL AIR or BISCAYNE

A1		Connect the main connector to this harness to the mating connector on the dash harness, 510361, bag G. Route this harness down along the LH driver's side door sill and back into trunk.		
	LIGHT BLUE	Third brake light	Connect to the third brake lamp, if equipped.	
A2		TAN	Gas gauge	Route this tan wire to the rear of the car, down thru access hole in trunk floor to the fuel sending unit, and cut to length. Slide grommet S onto this wire in the direction shown on sheet 3, then slide boot P onto this wire in the direction shown on sheet 3, and install terminal M onto the wire. Pull boot P up over terminal M and then attach this assembled wire onto the fuel sending unit.
C		BROWN	Rear running lights	Route this brown wire to the left side tail light area, trim to length, double it with the cut off portion, install terminal L and plug into connector F as shown on sheet 3. Route the loose end of this brown wire to the right side tail light area, trim to length, double it with the cut off portion, install terminal L and plug into connector F as shown on sheet 3. Route the remaining portion of this brown wire to the license plate lamp area, trim to length, install terminal J, and plug into connector H as shown on sheet 3. New terminal C and connector K have been provided for you to install onto your original license plate lamp lead. Plug your re-terminated license plate lamp lead (not included) into connector H as shown on sheet 3.
D				
E				
F				NOTE: You have been provided with tail lamp socket pigtails for the LH (A1) and RH (A2) sides of the car. Install terminals C and plug the brown, yellow, and dark green leads into connector E as shown on sheet 3.
H		YELLOW	Left rear turn	Route this yellow wire to the left side tail light area, trim to length, install terminal J and plug into the empty cavity of connector F as shown on sheet 3. Plug pigtail A1 into this connection to complete your LH tail lamp circuit.
J		DK GREEN	Right rear turn	Route this dark green wire to the right side tail light area, trim to length, install terminal J and plug into the empty cavity of connector F as shown on sheet 3. Plug pigtail A2 into this connection to complete your RH tail lamp circuit.
K				NOTE: You have been provided with back up lamp socket pigtails (T) for the LH and RH sides of the car. Plug these light green pigtail leads into connector K as shown on sheet 3.
L				
M		LT GREEN	Back up lt sw	Route this light green wire to the LH driver's side back up lamp area, trim to length, double it with the cut off portion, install terminal D, and plug into connector K as shown on sheet 3. Route the remaining portion of this wire over to the RH back up lamp area, trim to length, install terminal C, and plug into connector K as shown on sheet 3.
P				Note: There is a 2 way male connector directly off of the main connector. Your completed dome lamp harness will plug in there. Route the loose end of the orange wire doubled into this 2 way male connector to the LH driver's side trunk hinge area, trim to length, install terminal J, and plug into connector H as shown on sheet 3. Your factory trunk lamp (not included) will plug into this connection if your car has that option.
Q				
S		WHITE	Ctsy ground	(Sedan models) Install terminal Q onto the loose piece white wire and snap it into your dome lamp base. Route the loose end of this wire down the windshield pillar to the 2-way connector in the driver's kick panel area containing the orange and white wires, trim to length, install terminal C and plug into connector E as shown on sheet 3.
T		ORANGE	12v battery - fused	(Sedan models) Install terminal Q onto the loose piece orange wire and snap it into your dome lamp base. Route the loose end of this wire down the windshield pillar to the 2-way connector in the driver's kick panel area containing the orange and white wires, trim to length, install terminal C and plug into connector E as shown on sheet 3.

Classic Update Series

(2dr. Hardtop Only)

(Sedan Only)

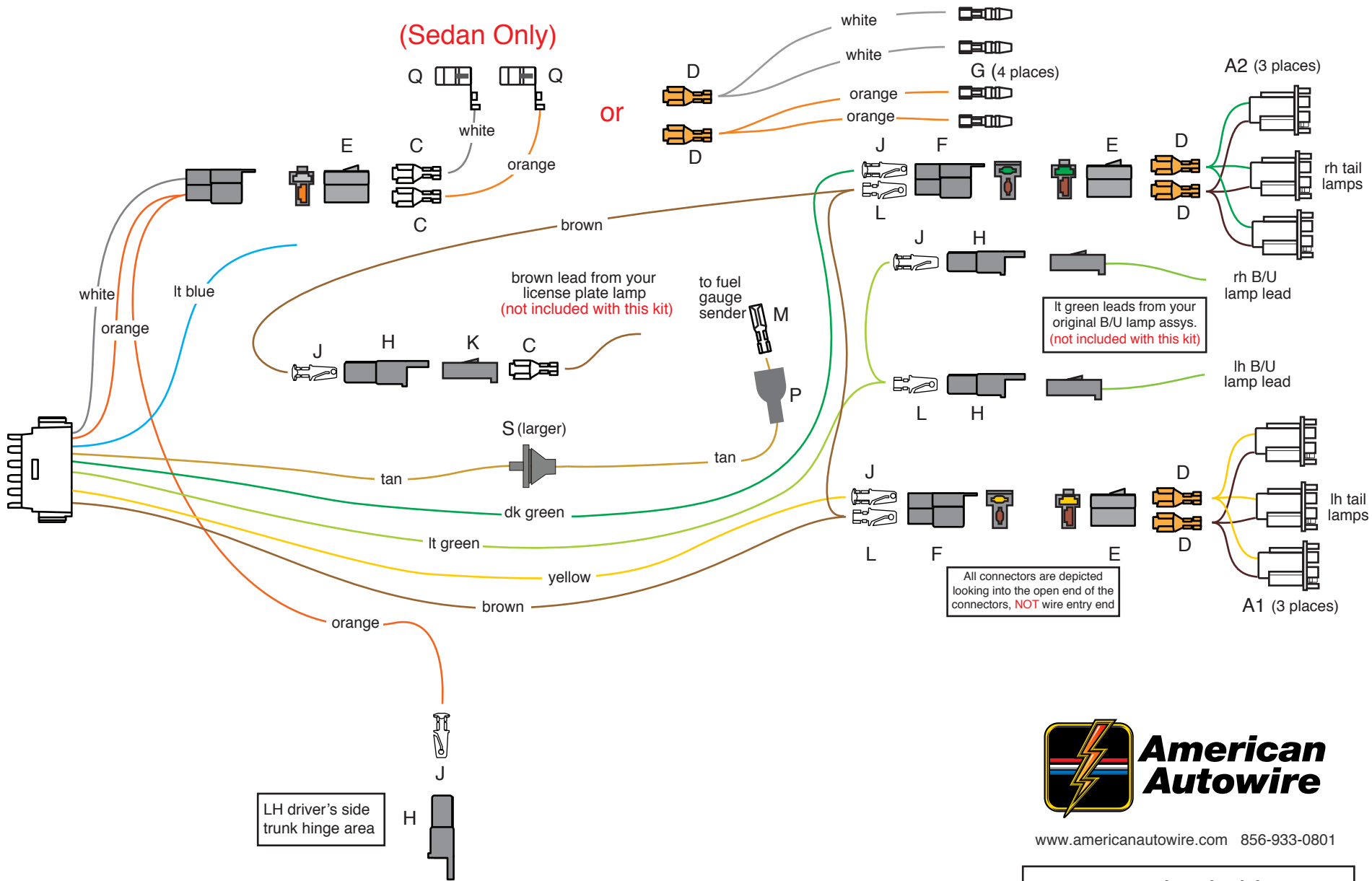

USE THIS SHEET FOR A
66 Impala or Caprice



www.americanautowire.com 856-933-0801

rear body kit
installation instructions
1965-68 IMPALA
510365
92970256 instruction rev 0.0 4/9/2013

USE THIS SHEET FOR A 66 IMPALA or CAPRICE

Connect the main connector on this harness to the mating connector on the dash harness, 510361, bag G. Route this harness down along the LH driver's side door sill and back into trunk.



LIGHT BLUE

Third brake light

Connect to the third brake lamp, if equipped.

TAN

Gas gauge

Route this tan wire to the rear of the car, down thru access hole in trunk floor to the fuel sending unit, and cut to length. Slide grommet S onto this wire in the direction shown on sheet 5, then slide boot P onto this wire in the direction shown on sheet 5, and install terminal M onto the wire. Pull boot P up over terminal M and then attach this assembled wire onto the fuel sending unit.



BROWN

Rear running lights

Route this brown wire to the left side tail light area, trim to length, double it with the cut off portion, install terminal L and plug into connector F as shown on sheet 5. Route the loose end of this brown wire to the right side tail light area, trim to length, double it with the cut off portion, install terminal L and plug into connector F as shown on sheet 5. Route the remaining portion of this brown wire to the license plate lamp area, trim to length, install terminal J, and plug into connector H as shown on sheet 5. New terminal C and connector K have been provided for you to install onto your original license plate lamp lead. Plug your re-terminated license plate lamp lead (**not included**) into connector H as shown on sheet 5.



NOTE: You have been provided with three tail lamp socket pigtails for the LH (A1) and RH (A2) sides of the car. Triple the yellow wires together, install terminal D (repeat for the browns and then the dark greens and the browns) and plug the brown / yellow, and brown / dark green leads into connectors E as shown on sheet 5.



YELLOW

Left rear turn

Route this yellow wire to the left side tail light area, trim to length, install terminal J and plug into the empty cavity of connector F as shown on sheet 5. Plug pigtail assembly A1 into this connection to complete your LH tail lamp circuit.

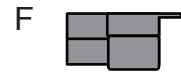

DK GREEN

Right rear turn

Route this dark green wire to the right side tail light area, trim to length, install terminal J and plug into the empty cavity of connector F as shown on sheet 5. Plug pigtail assembly A2 into this connection to complete your RH tail lamp circuit.



LT GREEN

Back up lt sw

Route this light green wire to the LH driver's side back up lamp area, trim to length, double it with the cut off portion, install terminal L, and plug into connector H as shown on sheet 5. Route the remaining portion of this wire over to the RH back up lamp area, trim to length, install terminal J, and plug into connector H as shown on sheet 5. Plug your factory back up lamp leads (**not included**) into connectors H to complete your back up lamp circuits.



Note: There is a 2 way male connector directly off of the main connector. Your completed dome lamp harness will plug in there. Route the loose end of the orange wire doubled into this 2 way male connector to the LH driver's side trunk hinge area, trim to length, install terminal J, and plug into connector H as shown on sheet 5. Your factory trunk lamp (**not included**) will plug into this connection if your car has that option.

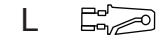

WHITE

Ctsy ground

(Sedan models) Install terminal Q onto the loose piece white wire and snap it into your dome lamp base. Route the loose end of this wire down the windshield pillar to the 2-way connector in the driver's kick panel area containing the orange and white wires, trim to length, install terminal C and plug into connector E as shown on page 5.

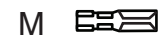

(Sport coupe models) Install terminal G onto the loose piece white wire and snap it into your LH rear sail panel lamp. Route the loose end of this wire down the LH windshield pillar to the 2-way connector in the driver's kick panel area containing the orange and white wires, and trim to length. Install terminal G onto the remaining portion of the white wire and snap it into your RH rear sail panel lamp. Route the loose end of this wire across the roof, then down the LH windshield pillar to the 2-way connector in the driver's kick panel area containing the orange and white wires and trim to length. Double the two white wires together, install terminal D and plug into connector E as shown on page 5.



ORANGE

12v battery - fused



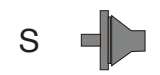







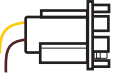
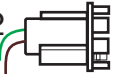

(Sedan models) Install terminal Q onto the loose piece orange wire and snap it into your dome lamp base. Route the loose end of this wire down the windshield pillar to the 2-way connector in the driver's kick panel area containing the orange and white wires, trim to length, install terminal C and plug into connector E as shown on sheet 5.

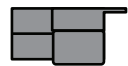

(Sport coupe models) Install terminal G onto the loose piece orange wire and snap it into your LH rear sail panel lamp. Route the loose end of this wire down the LH windshield pillar to the 2-way connector in the driver's kick panel area containing the orange and white wires, and trim to length. Install terminal G onto the remaining portion of the orange wire and snap it into your RH rear sail panel lamp. Route the loose end of this wire across the roof, then down the LH windshield pillar to the 2-way connector in the driver's kick panel area containing the orange and white wires and trim to length. Double the two orange wires together, install terminal D and plug into connector E as shown on sheet 5.

USE THIS SHEET FOR A 67 BISCAYNE

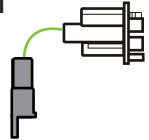
Connect the main connector on this harness to the mating connector on the dash harness, 510361, bag G. Route this harness down along the LH driver's side door sill and back into trunk.

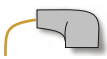
A1		LIGHT BLUE	Third brake light	Connect to the third brake lamp, if equipped.
		TAN	Gas gauge	Route this tan wire to the rear of the car near access hole in trunk floor to the fuel sending unit, cut to length, install terminal J and plug into connector H as shown on sheet 7. Install fuel tank extension V onto your fuel sending unit, then route that tan wire up thru the access hole in the trunk floor so that it is near the tan wire with connector H installed on it, slide grommet U onto this extension wire in the direction shown on sheet 7, trim the wire to length, install terminal C, plug into connector K, then plug connector K into connector H as shown on sheet 7.
A2				
C		BROWN	Rear running lights	Route this brown wire to the left side tail light area, trim to length, double it with the cut off portion, install terminal L and plug into connector F as shown on sheet 7. Route the loose end of this brown wire to the right side tail light area, trim to length, double it with the cut off portion, install terminal L and plug into connector F as shown on sheet 7. Route the remaining portion of this brown wire to the license plate lamp area, trim to length, install terminal J, and plug into connector H as shown on sheet 7. New terminal C and connector K have been provided for you to install onto your original license plate lamp lead. Plug your re-terminated license plate lamp lead (not included) into connector H as shown on sheet 7.
D				
E				
F				NOTE: You have been provided with tail lamp socket pigtails for the LH (A1) and RH (A2) sides of the car. Install terminals C and plug the brown, yellow, and dark green leads into connector E as shown on sheet 7.
H		YELLOW	Left rear turn	Route this yellow wire to the left side tail light area, trim to length, install terminal J and plug into the empty cavity of connector F as shown on sheet 7. Plug pigtail A1 into this connection to complete your LH tail lamp circuit.
J		DK GREEN	Right rear turn	Route this dark green wire to the right side tail light area, trim to length, install terminal J and plug into the empty cavity of connector F as shown on sheet 7. Plug pigtail A2 into this connection to complete your RH tail lamp circuit.
K				NOTE: You have been provided with back up lamp socket pigtails (T) for the LH and RH sides of the car. Plug these light green pigtail leads into connector K as shown on sheet 7.
L				
Q		LT GREEN	Back up lt sw	Route this light green wire to the LH driver's side back up lamp area, trim to length, double it with the cut off portion, install terminal D, and plug into connector K as shown on sheet 7. Route the remaining portion of this wire over to the RH back up lamp area, trim to length, install terminal C, and plug into connector K as shown on sheet 7.
T				Note: There is a 2 way male connector directly off of the main connector. Your completed dome lamp harness will plug in there. Route the loose end of the orange wire doubled into this 2 way male connector to the LH driver's side trunk hinge area, trim to length, install terminal J, and plug into connector H as shown on sheet 7. Your factory trunk lamp (not included) will plug into this connection if your car has that option.
U		WHITE	Ctsy ground	(Sedan models) Install terminal Q onto the loose piece white wire and snap it into your dome lamp base. Route the loose end of this wire down the windshield pillar to the 2-way connector in the driver's kick panel area containing the orange and white wires, trim to length, install terminal C and plug into connector E as shown on sheet 7.
V		ORANGE	12v battery - fused	(Sedan models) Install terminal Q onto the loose piece orange wire and snap it into your dome lamp base. Route the loose end of this wire down the windshield pillar to the 2-way connector in the driver's kick panel area containing the orange and white wires, trim to length, install terminal C and plug into connector E as shown on sheet 7.

USE THIS SHEET FOR A 67 IMPALA or BEL AIR

Classic Update Series

Connect the main connector on this harness to the mating connector on the dash harness, 510361, bag G. Route this harness down along the LH driver's side door sill and back into trunk.



LIGHT BLUE Third brake light
TAN Gas gauge

Connect to the third brake lamp, if equipped.

Route this tan wire to the rear of the car near access hole in trunk floor to the fuel sending unit, cut to length, install terminal J and plug into connector H as shown on sheet 9. Install fuel tank extension V onto your fuel sending unit, then route that tan wire up thru the access hole in the trunk floor so that it is near the tan wire with connector H installed on it, slide grommet U onto this extension wire in the direction shown on sheet 9, trim the wire to length, install terminal C, plug into connector K, then plug connector K into connector H as shown on sheet 9.

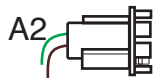

BROWN Rear running lights

Route this brown wire to the left side tail light area, trim to length, double it with the cut off portion, install terminal L and plug into connector F as shown on sheet 9. Route the loose end of this brown wire to the right side tail light area, trim to length, double it with the cut off portion, install terminal L and plug into connector F as shown on sheet 9. Route the remaining portion of this brown wire to the license plate lamp area, trim to length, install terminal J, and plug into connector H as shown on sheet 9. New terminal C and connector K have been provided for you to install onto your original license plate lamp lead. Plug your re-terminated license plate lamp lead (not included) into connector H as shown on sheet 9.



NOTE: You have been provided with two tail lamp socket pigtails for the LH (A1) and RH (A2) sides of the car. Double the yellow wires together, install terminal D (repeat for the browns and then the dark greens and the browns) and plug the brown / yellow, and brown / dark green leads into connectors E as shown on sheet 9.



YELLOW Left rear turn

Route this yellow wire to the left side tail light area, trim to length, install terminal J and plug into the empty cavity of connector F as shown on sheet 9. Plug pigtail assembly A1 into this connection to complete your LH tail lamp circuit.



DK GREEN Right rear turn

Route this dark green wire to the right side tail light area, trim to length, install terminal J and plug into the empty cavity of connector F as shown on sheet 9. Plug pigtail assembly A2 into this connection to complete your RH tail lamp circuit.

NOTE: You have been provided with back up lamp socket pigtails (T) for the LH and RH sides of the car. Plug these light green pigtail leads into connector K as shown on sheet 9.



LT GREEN Back up lt sw

Route this light green wire to the LH driver's side back up lamp area, trim to length, double it with the cut off portion, install terminal D, and plug into connector K as shown on sheet 9. Route the remaining portion of this wire over to the RH back up lamp area, trim to length, install terminal C, and plug into connector K as shown on sheet 9.



Note: There is a 2 way male connector directly off of the main connector. Your completed dome lamp harness will plug in there. Route the loose end of the orange wire doubled into this 2 way male connector to the LH driver's side trunk hinge area, trim to length, install terminal J, and plug into connector H as shown on sheet 9. Your factory trunk lamp (not included) will plug into this connection if your car has that option.



WHITE Ctsy ground

(Sedan models) Install terminal Q onto the loose piece white wire and snap it into your dome lamp base. Route the loose end of this wire down the windshield pillar to the 2-way connector in the driver's kick panel area containing the orange and white wires, trim to length, install terminal C and plug into connector E as shown on sheet 9.

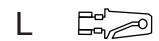

(Sport coupe and 4dr. HT models) Install terminal G onto the loose piece white wire and snap it into your LH rear sail panel lamp. Route the loose end of this wire down the LH windshield pillar to the 2-way connector in the driver's kick panel area containing the orange and white wires, and trim to length. Install terminal G onto the remaining portion of the white wire and snap it into your RH rear sail panel lamp. Route the loose end of this wire across the roof, then down the LH windshield pillar to the 2-way connector in the driver's kick panel area containing the orange and white wires and trim to length. Double the two white wires together, install terminal D and plug into connector E as shown on sheet 9.



ORANGE 12v battery - fused

(Sedan models) Install terminal Q onto the loose piece orange wire and snap it into your dome lamp base. Route the loose end of this wire down the windshield pillar to the 2-way connector in the driver's kick panel area containing the orange and white wires, trim to length, install terminal C and plug into connector E as shown on sheet 9.

(Sport coupe and 4dr. HT models) Install terminal G onto the loose piece orange wire and snap it into your LH rear sail panel lamp. Route the loose end of this wire down the LH windshield pillar to the 2-way connector in the driver's kick panel area containing the orange and white wires, and trim to length. Install terminal G onto the remaining portion of the orange wire and snap it into your RH rear sail panel lamp. Route the loose end of this wire across the roof, then down the LH windshield pillar to the 2-way connector in the driver's kick panel area containing the orange and white wires and trim to length. Double the two orange wires together, install terminal D and plug into connector E as shown on sheet 9.



USE THIS SHEET FOR A 67 CAPRICE

Connect the main connector on this harness to the mating connector on the dash harness, 510361, bag G. Route this harness down along the LH driver's side door sill and back into trunk.



LIGHT BLUE

Third brake light

Connect to the third brake lamp, if equipped.

TAN

Gas gauge

Route this tan wire to the rear of the car near access hole in trunk floor to the fuel sending unit, cut to length, install terminal J and plug into connector H as shown on sheet 11. Install fuel tank extension V onto your fuel sending unit, then route that tan wire up thru the access hole in the trunk floor so that it is near the tan wire with connector H installed on it, slide grommet U onto this extension wire in the direction shown on sheet 11, trim the wire to length, install terminal C, plug into connector K, then plug connector K into connector H as shown on sheet 11.

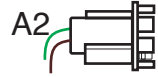

BROWN

Rear running lights

Route this brown wire to the left side tail light area, trim to length, double it with the cut off portion, install terminal L and plug into connector F as shown on sheet 11. Route the loose end of this brown wire to the right side tail light area, trim to length, double it with the cut off portion, install terminal L and plug into connector F as shown on sheet 11. Route the remaining portion of this brown wire to the license plate lamp area, trim to length, install terminal J, and plug into connector H as shown on sheet 11. New terminal C and connector K have been provided for you to install onto your original license plate lamp lead. Plug your re-terminated license plate lamp lead (not included) into connector H as shown on sheet 11.



NOTE: You have been provided with three tail lamp socket pigtails for the LH (A1) and RH (A2) sides of the car. Triple the yellow wires together, install terminal D (repeat for the browns and then the dark greens and the browns) and plug the brown / yellow, and brown / dark green leads into connectors E as shown on sheet 11.

YELLOW

Left rear turn

Route this yellow wire to the left side tail light area, trim to length, install terminal J and plug into the empty cavity of connector F as shown on sheet 11. Plug pigtail assembly A1 into this connection to complete your LH tail lamp circuit.

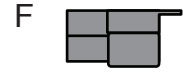

DK GREEN

Right rear turn

Route this dark green wire to the right side tail light area, trim to length, install terminal J and plug into the empty cavity of connector F as shown on sheet 11. Plug pigtail assembly A2 into this connection to complete your RH tail lamp circuit.



LT GREEN

Back up lt sw

Route this light green wire to the LH driver's side back up lamp area, trim to length, double it with the cut off portion, install terminal L, and plug into connector H as shown on sheet 11. Route the remaining portion of this wire over to the RH back up lamp area, trim to length, install terminal J, and plug into connector H as shown on sheet 11. Plug your factory back up lamp leads (not included) into connectors H to complete your back up lamp circuits

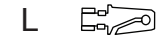

Note: There is a 2 way male connector directly off of the main connector. Your completed dome lamp harness will plug in there. Route the loose end of the orange wire doubled into this 2 way male connector to the LH driver's side trunk hinge area, trim to length, install terminal J, and plug into connector H as shown on sheet 11. Your factory trunk lamp (not included) will plug into this connection if your car has that option.

WHITE

Ctsy ground

(Sport coupe and 4dr. HT models) Install terminal G onto the loose piece white wire and snap it into your LH rear sail panel lamp. Route the loose end of this wire down the LH windshield pillar to the 2-way connector in the driver's kick panel area containing the orange and white wires, and trim to length. Install terminal G onto the remaining portion of the white wire and snap it into your RH rear sail panel lamp. Route the loose end of this wire across the roof, then down the LH windshield pillar to the 2-way connector in the driver's kick panel area containing the orange and white wires and trim to length. Double the two white wires together, install terminal D and plug into connector E as shown on sheet 11.



ORANGE

12v battery - fused

(Sport coupe and 4dr. HT models) Install terminal G onto the loose piece orange wire and snap it into your LH rear sail panel lamp. Route the loose end of this wire down the LH windshield pillar to the 2-way connector in the driver's kick panel area containing the orange and white wires, and trim to length. Install terminal G onto the remaining portion of the orange wire and snap it into your RH rear sail panel lamp. Route the loose end of this wire across the roof, then down the LH windshield pillar to the 2-way connector in the driver's kick panel area containing the orange and white wires and trim to length. Double the two orange wires together, install terminal D and plug into connector E as shown on sheet 11.

Classic Update Series

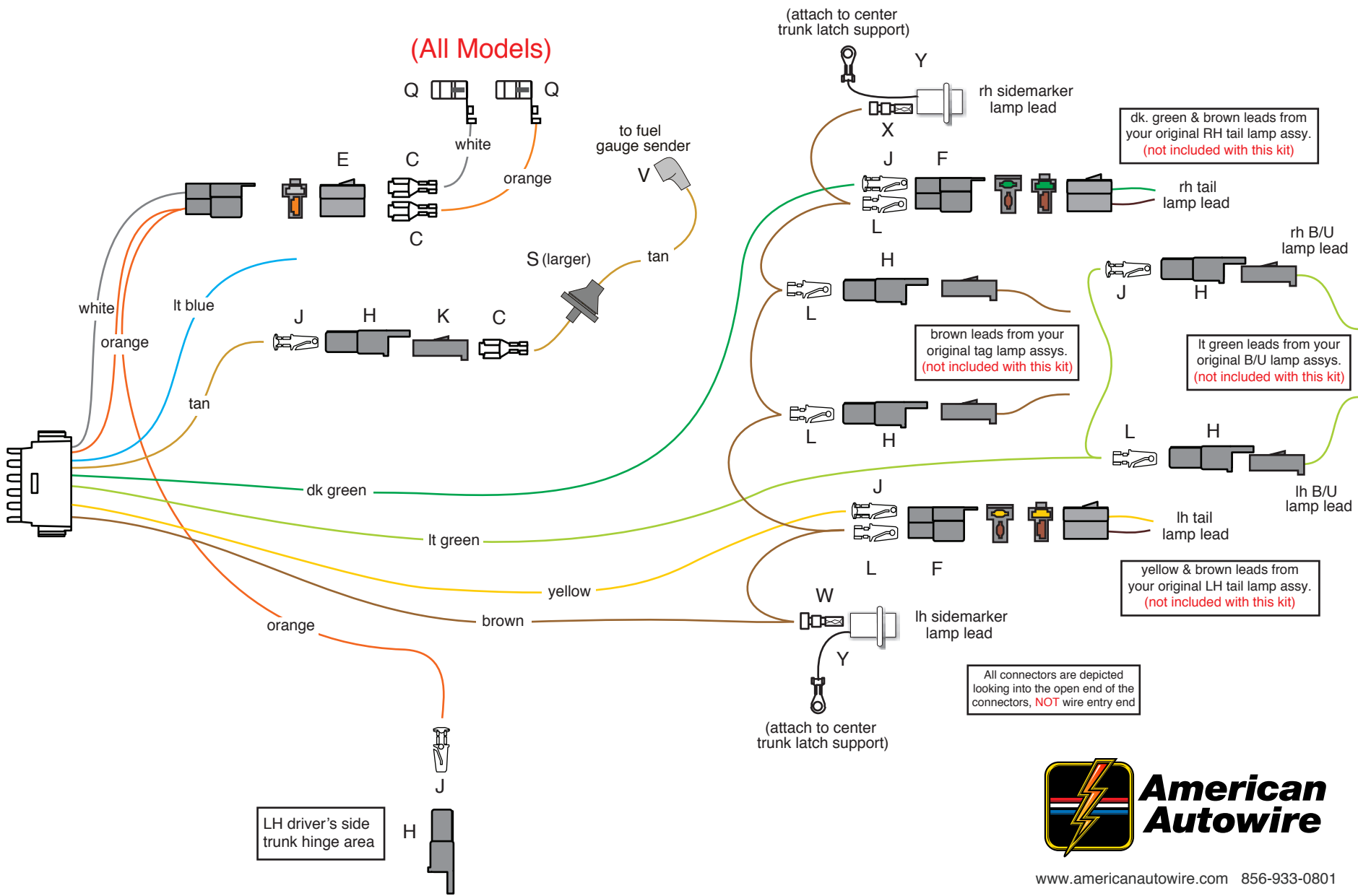

USE THIS SHEET FOR A
68 Bel Air or Biscayne













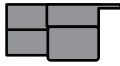

www.americanautowire.com 856-933-0801

rear body kit
installation instructions
1965-68 IMPALA
510365
92970256 instruction rev 0.0 4/9/2013

USE THIS SHEET FOR A 68 BEL AIR or BISCAYNE

Connect the main connector to this harness to the mating connector on the dash harness, 510361, bag G. Route this harness down along the LH driver's side door sill and back into trunk.

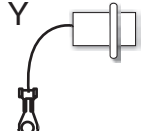
C		LIGHT BLUE	Third brake light	Connect to the third brake lamp, if equipped.
D		TAN	Gas gauge	Route this tan wire to the rear of the car near access hole in trunk floor to the fuel sending unit, cut to length, install terminal J and plug into connector H as shown on sheet 13. Install fuel tank extension V onto your fuel sending unit, then route that tan wire up thru the access hole in the trunk floor so that it is near the tan wire with connector H installed on it, slide grommet S onto this extension wire in the direction shown on sheet 13, trim the wire to length, install terminal C, plug into connector K, then plug connector K into connector H as shown on sheet 13.
E		BROWN	Rear running lights	Route this brown wire to the left hand side marker lamp area, trim to length, double it with the cut off portion, install terminal W, and plug into lamp socket pigtail assembly Y as shown on sheet 13. Route the loose end of this brown wire to the left side tail light area, trim to length, double it with the cut off portion, install terminal L and plug into connector F as shown on sheet 13. Route the loose end of this brown wire to the left side license plate lamp area, trim to length, install terminal L, and plug into connector H as shown on sheet 13. Route the loose end of this brown wire to the right side license plate lamp area, trim to length, install terminal L, and plug into connector H as shown on sheet 13. Route the loose end of this brown wire to the right side tail light area, trim to length, double it with the cut off portion, install terminal L and plug into connector F as shown on sheet 13. Route the remaining portion of this brown wire to the right hand side marker lamp area, trim to length, install terminal X, and plug into the other lamp socket pigtail assembly Y as shown on sheet 13. Attach the two ring terminals (grounds) on the black wires from the side marker pigtail assemblies Y together at the trunk latch area to complete the side marker circuits. Plug your factory original license plate lamp leads (not included) into connectors H as shown on sheet 13.
F				
H				
J				
K				NOTE: Your factory tail lamp leads will plug into connectors F from below to complete your stop/tail lamp wiring circuits.
L		YELLOW	Left rear turn	Route this yellow wire to the left side tail light area, trim to length, install terminal J and plug into the empty cavity of connector F as shown on sheet 13. Plug your LH factory tail lamp lead (not included) into this connection to complete your LH tail lamp circuit.
Q		DK GREEN	Right rear turn	Route this dark green wire to the right side tail light area, trim to length, install terminal J and plug into the empty cavity of connector F as shown on sheet 13. Plug your RH factory tail lamp lead (not included) into this connection to complete your RH tail lamp circuit.
S		LT GREEN	Back up lt sw	Route this light green wire to the LH driver's side back up lamp area, trim to length, double it with the cut off portion, install terminal L, and plug into connector H as shown on sheet 13. Route the remaining portion of this wire over to the RH back up lamp area, trim to length, install terminal J, and plug into connector H as shown on sheet 13. Plug your factory back up lamp leads (not included) into connectors H to complete your back up lamp circuits
V				Note: There is a 2 way male connector directly off of the main connector. Your completed dome lamp harness will plug in there. Route the loose end of the orange wire doubled into this 2 way male connector to the LH driver's side trunk hinge area, trim to length, install terminal J, and plug into connector H as shown on sheet 13. Your factory trunk lamp (not included) will plug into this connection if your car has that option.
W				
X		WHITE	Ctsy ground	(All models) Install terminal Q onto the loose piece white wire and snap it into your dome lamp base. Route the loose end of this wire down the windshield pillar to the 2-way connector in the driver's kick panel area containing the orange and white wires, trim to length, install terminal C and plug into connector E as shown on sheet 13.
Y		ORANGE	12v battery - fused	(All models) Install terminal Q onto the loose piece orange wire and snap it into your dome lamp base. Route the loose end of this wire down the windshield pillar to the 2-way connector in the driver's kick panel area containing the orange and white wires, trim to length, install terminal C and plug into connector E as shown on sheet 13.

Classic Update Series

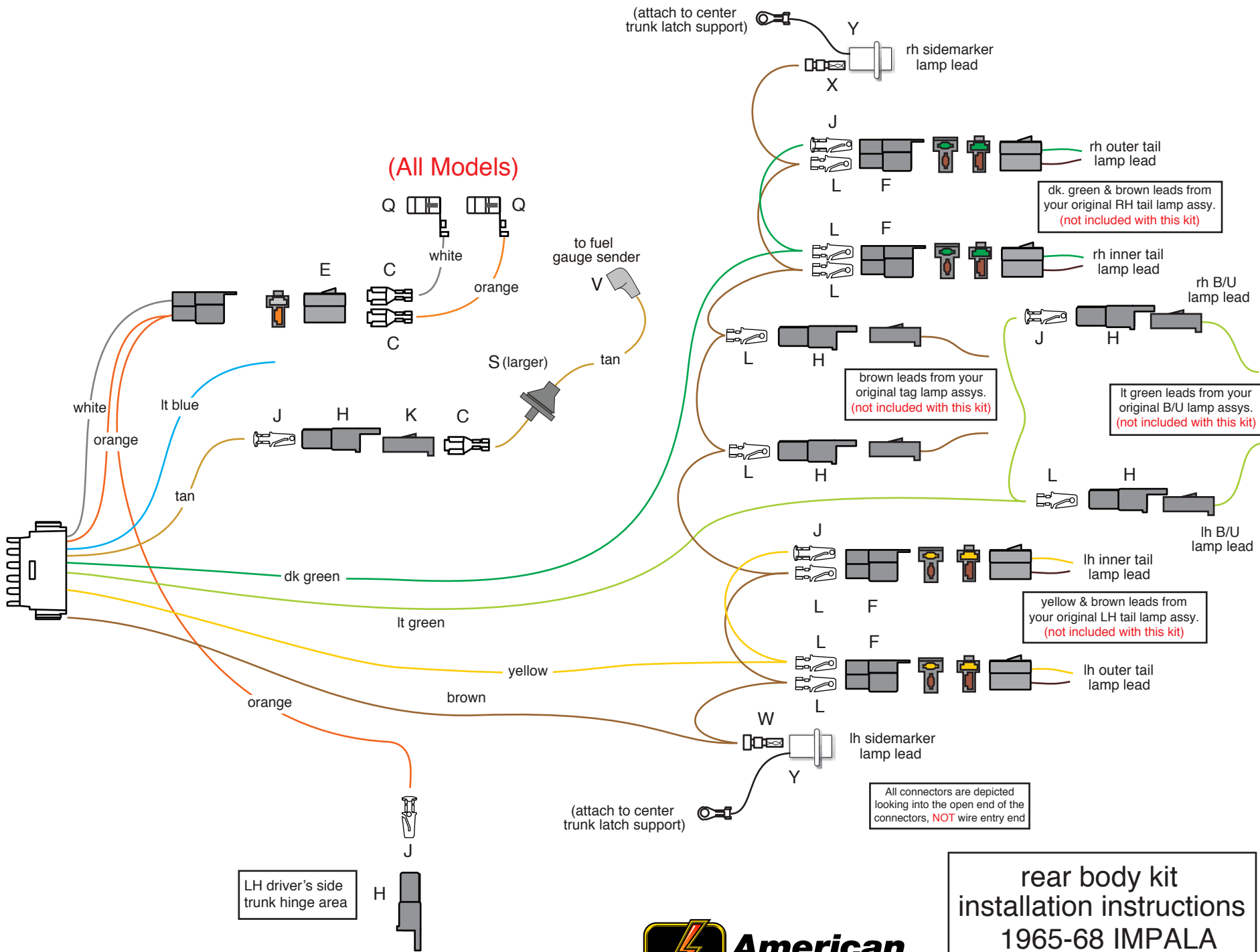

USE THIS SHEET FOR A
68 Impala or Caprice

















**American
 Autowire**

rear body kit
 installation instructions
 1965-68 IMPALA
510365
 92970256 instruction rev 0.0 4/9/2013

USE THIS SHEET FOR A 68 IMPALA or CAPRICE

Connect the main connector to this harness to the mating connector on the dash harness, 510361, bag G. Route this harness down along the LH driver's side door sill and back into trunk.

C		LIGHT BLUE	Third brake light	Connect to the third brake lamp, if equipped.
D		TAN	Gas gauge	Route this tan wire to the rear of the car near access hole in trunk floor to the sending unit, cut to length, install terminal J and plug into connector H as shown on sheet 15. Install fuel tank extension V onto your sending unit, then route that tan wire up thru the access hole in the trunk floor so that it is near the tan wire with connector H installed on it, slide grommet S onto this extension wire in the direction shown on sheet 15, trim the wire to length, install terminal C, plug into connector K, then plug connector K into connector H as shown on sheet 15.
E		BROWN	Rear running lights	Route this brown wire to the left hand side marker lamp area, trim to length, double it with the cut off portion, install terminal W, and plug into lamp socket pigtail assembly Y as shown on sheet 15. Route the loose end of this brown wire to the outer left side tail light area, trim to length, double it with the cut off portion, install terminal L and plug into connector F as shown on sheet 15. Route the loose end of this brown wire to the inner left side tail light area, trim to length, double it with the cut off portion, install terminal L and plug into connector F as shown on sheet 15. Route the loose end of this brown wire to the left side license plate lamp area, trim to length, install terminal L, and plug into connector H as shown on sheet 15. Route the loose end of this brown wire to the right side license plate lamp area, trim to length, install terminal L, and plug into connector H as shown on sheet 15. Route the loose end of this brown wire to the inner right side tail light area, trim to length, double it with the cut off portion, install terminal L and plug into connector F as shown on sheet 15. Route the loose end of this brown wire to the outer right side tail light area, trim to length, double it with the cut off portion, install terminal L and plug into connector F as shown on sheet 15. Route the remaining portion of this brown wire to the right hand side marker lamp area, trim to length, install terminal X, and plug into the other lamp socket pigtail assembly Y as shown on sheet 15. Attach the two ring terminals (grounds) on the black wires from the side marker pigtail assemblies Y together at the trunk latch area to complete the side marker circuits. Plug your factory original license plate lamp leads (not included) into connectors H as shown on sheet 15.
F				
H				
J				
K				
L				
Q		YELLOW	Left rear turn	Route this yellow wire to the outer left side tail light area, trim to length, double it with the cut off portion, install terminal L and plug into the empty cavity of connector F as shown on sheet 15. Route the remaining portion of this yellow wire to the inner left side tail light area, trim to length, install terminal J and plug into the empty cavity of connector F as shown on sheet 15. Plug your inner and outer factory LH tail lamp leads (not included) into these two connections to complete your LH tail lamp circuits.
S		DK GREEN	Right rear turn	Route this dark green wire to the inner right side tail light area, trim to length, double it with the cut off portion, install terminal L and plug into the empty cavity of connector F as shown on sheet 15. Route the remaining portion of this dark green wire to the outer right side tail light area, trim to length, install terminal J and plug into the empty cavity of connector F as shown on sheet 15. Plug your inner and outer factory RH tail lamp leads (not included) into these two connections to complete your RH tail lamp circuits.
V				
W		LT GREEN	Back up lt sw	Route this light green wire to the LH driver's side back up lamp area, trim to length, double it with the cut off portion, install terminal L, and plug into connector H as shown on sheet 15. Route the remaining portion of this wire over to the RH back up lamp area, trim to length, install terminal J, and plug into connector H as shown on sheet 15. Plug your factory back up lamp leads (not included) into connectors H to complete your back up lamp circuits
X				
Y		WHITE	Ctsy ground	Note: There is a 2 way male connector directly off of the main connector. Your completed dome lamp harness will plug in there. Route the loose end of the orange wire doubled into this 2 way male connector to the LH driver's side trunk hinge area, trim to length, install terminal J, and plug into connector H as shown on sheet 15. Your factory trunk lamp (not included) will plug into this connection if your car has that option.
		ORANGE	12v battery - fused	(All models) Install terminal Q onto the loose piece white wire and snap it into your dome lamp base. Route the loose end of this wire down the windshield pillar to the 2-way connector in the driver's kick panel area containing the orange and white wires, trim to length, install terminal C and plug into connector E as shown on sheet 15.
				(All models) Install terminal Q onto the loose piece orange wire and snap it into your dome lamp base. Route the loose end of this wire down the windshield pillar to the 2-way connector in the driver's kick panel area containing the orange and white wires, trim to length, install terminal C and plug into connector E as shown on sheet 15.

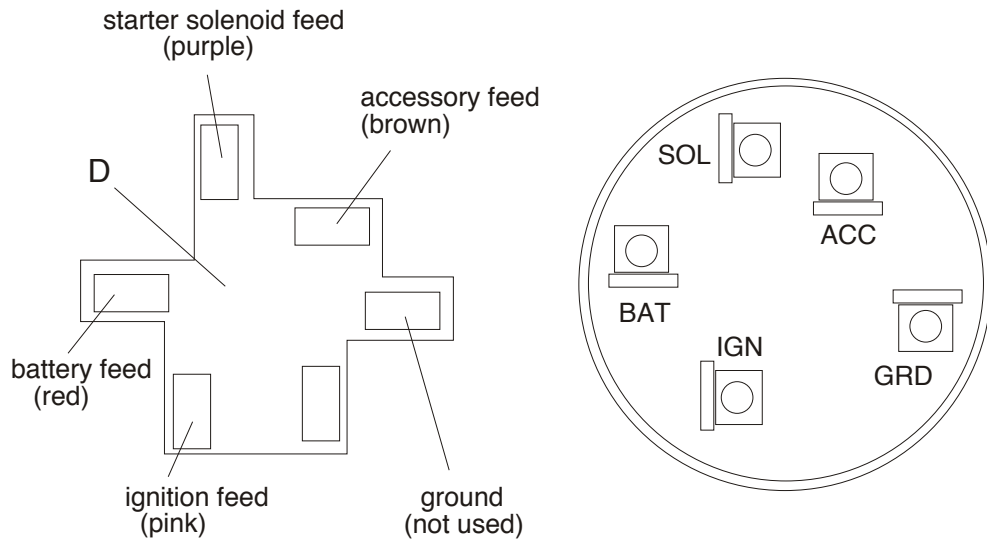

NOTE: View from back of connector.

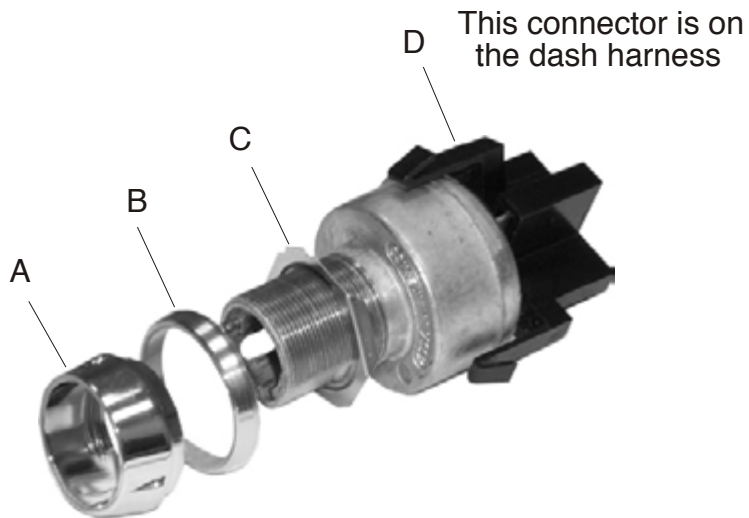

NOTE: Please keep in mind that this is an upgraded switch, not an original replacement, and as such, the flat side on this switch may be in a different location than was your original. If you mount this new AAW switch in your dash and the flat side is in fact in a different location, the key may not line up as the original did. This will not alter the performance of the switch in any way. If you wish for your key to line up as it did in the OEM application, you will need to file out the flat spot in your original dash opening so that the switch can be rotated to the correct position. Once the backing nut C is set so that the depth of the switch is correct for your application, and bezel nut A is firmly tightened, the switch will be secure and will not rotate.

INSTALLATION:

NOTE: The instruction sheet packaged with this switch shows a copper lamp holder bracket. That bracket is not used in this application and it's installation can be ignored.

1. Due to the nature of the chrome plating on threaded collar A, AAW recommends threading the nut on and off of the switch by hand a few times to clean up the threads before installing the switch into your dash.
2. Plug in connector D from the dash wiring harness (bag G).
3. Install the back-up nut C onto the switch. The depth of this nut will have to be determined when mounting the switch.
4. Insert the switch into the hole in the dash panel.
5. Install your original dash bezel plate.
6. Slide on collar B.
7. Screw on threaded collar A
8. Insert your original or New AAW lock cylinder into the new switch to complete your installation.

NOTE: AAW has new lock cylinders with the correct GM style keys for your new 500684 ignition switch. Check below for your vehicle's correct application.



AAW P/N 500672 (with finger guard):

- 500423 - 1955-56 Chevy car
- 500434 - 1957 Chevy car
- 500481 - 1955-59 Chevy Truck
- 510217 - 1959-60 Chevy Impala
- 510063 - 1961-64 Chevy Impala
- 510267 - 1953-62 Chevy Corvette



AAW P/N 500674 (smooth face):

- 500467 - 1947-55 Chevy Truck
- 500560 - 1960-66 Chevy truck
- 510360 - 1965 Chevy Impala
- 510372 - 1966-68 Chevy Impala



**American
Autowire**

www.americanautowire.com 856-933-0801

IGNITION SWITCH
Classic Update Series
VARIOUS APPLICATIONS

500684

92965941 instruction rev 6.0 8/1/2018

A  (1)
 (144.0" 6 Gauge charge wire)

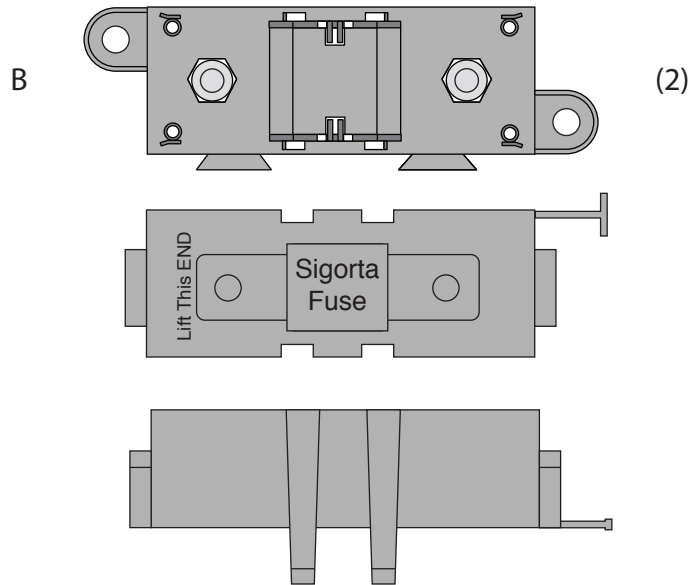

1. On this page, you will find the wire, fuse bodies, fuses, boot, ring terminals, and shrink tubing (items A through K) that are necessary to connect your alternator and main power feed for your new AAW wiring kit. Please be sure that all of the necessary components are present before starting this portion of your installation. If anything is missing, stop what you are doing and contact AAW at the number listed below right away.

2. On page 2, you will find directions for building the 2 Megafuse assemblies (items B,C and D) into one unit.

3. On page 3, you will find an overall concept of how to connect the Megafuse assemblies to your starter solenoid, alternator and main power feed of your new wiring system.

4. On page 4, you will find tips on building your charging circuit wires and assembling them and the main panel power feed wire to the Megafuse assemblies.

(Megafuse body, cover and two M8 x 1.25 nuts / lock washers)

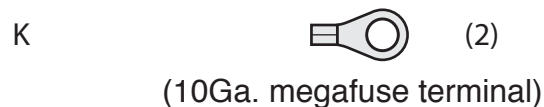
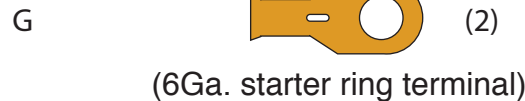
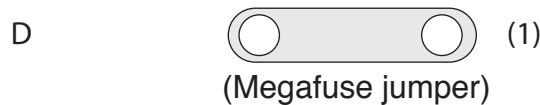
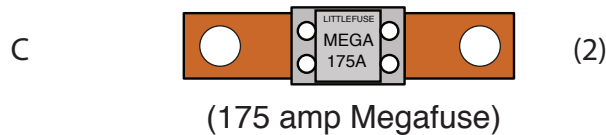

www.americanautowire.com 856-933-0801

PART #

510476

Z

DESCRIPTION:

Alternator and Main Power
 Connection Kit
 Various Applications

92972153 instruction sheet rev 0.1 6/24/2019

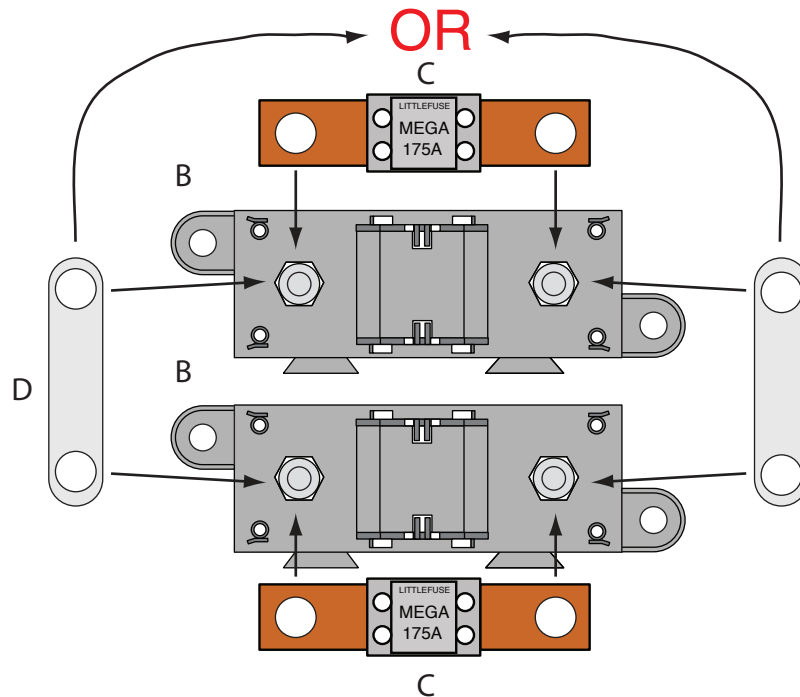

Assembling the (2) Megafuse assemblies

NOTE: Find a suitable place, as close to the battery power source as possible, under the hood of your vehicle to mount the completed Megafuse assemblies. Keep in mind that you have 12 feet of 6Ga. charging wire, and that the main power feed coming from your panel or bulkhead connection must also be able to reach the assembly.

1. Take the two Megafuse bodies and covers (items B) and snap them together. Remove the 4 nuts and lock washers from the studs on the fuse body assemblies.
2. Install the Megafuse jumper (item D above) over two of the studs on the Megafuse bodies. It is very important that the jumper **MUST BE** assembled on the side that is going to connect to your main power connection (starter solenoid or battery feed).
3. Notch top cover to clear jumper D as shown at right.
4. Snap one 175amp fuse (items C) onto the studs of each of the two Megafuse bodies (items B), over the jumper, then loosely re-attach the 4 nuts and lock washers back onto the assembled Megafuses. The fuse assemblies are ready to install into your vehicle.

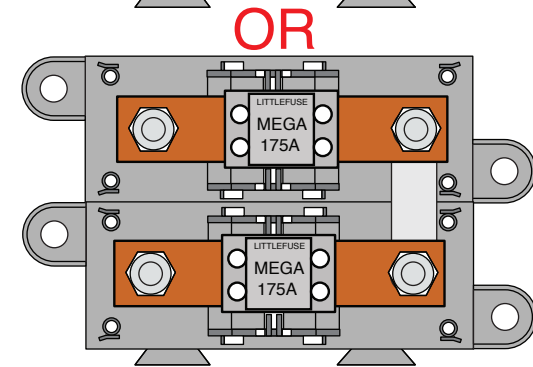
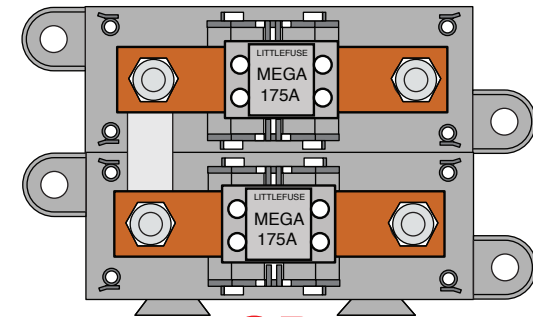

Assembled Megafuses

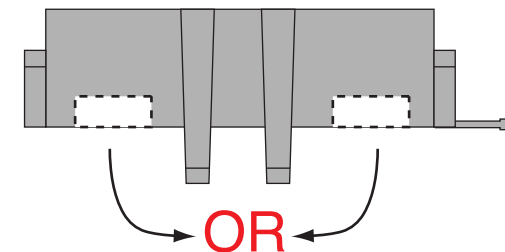

Notched Cover

PART #

510476

Z

DESCRIPTION:

Alternator and Main Power
Connection Kit
Various Applications

92972153 instruction sheet rev 0.1 6/24/2019

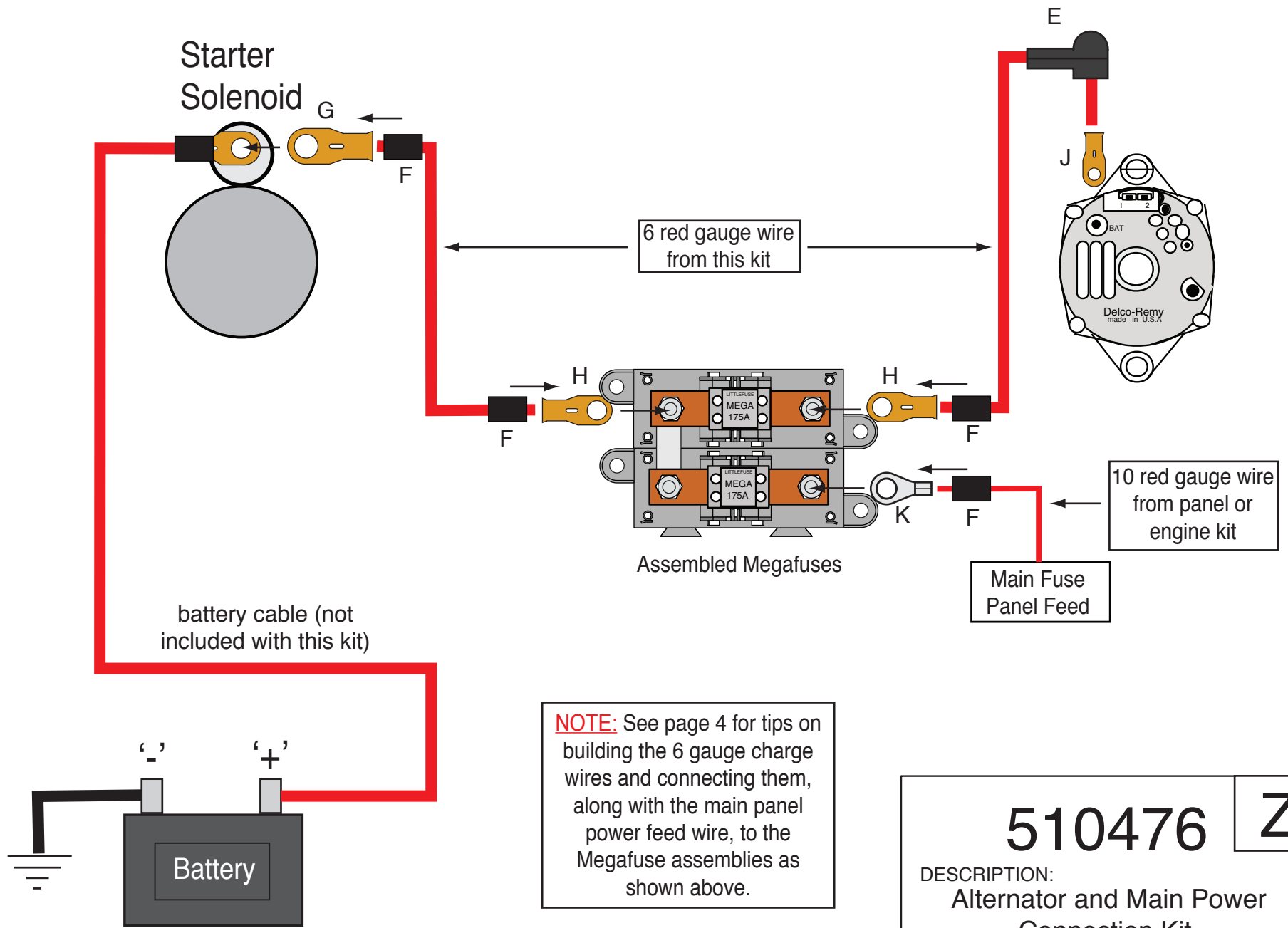

NOTE: See page 4 for tips on building the 6 gauge charge wires and connecting them, along with the main panel power feed wire, to the Megafuse assemblies as shown above.

<h1>510476</h1>	Z
<p>DESCRIPTION: Alternator and Main Power Connection Kit Various Applications</p>	
<p>92972153 instruction sheet rev 0.1 6/24/2019</p>	

Building the 6Ga. charge wires and connecting them and the main panel power feed wire to the Megafuse assemblies:

NOTE: Make sure that your battery is disconnected! You will need to install the preassembled Megafuses from page 2 in your vehicle to start this part of the installation.

1. Pre-cut item F shrink tubing into (6) 1.00" - 1.25" pieces.
2. Take the 12-foot piece of 6Ga. red wire from this kit and route it from your starter (or other battery feed) over to the area where you have mounted your Megafuse and cut it to length. Strip the insulation on each end back 1/2". Install 2 pieces of shrink tubing F onto the wire. At the starter end, crimp and solder (1) of terminal G onto the wire. At the Megafuse end, crimp and solder (1) of terminal H onto the wire. Slide the shrink tubing over the terminals and heat it up to shrink it down.
3. Take the remaining portion of the 12-foot piece of 6Ga. red wire from this kit and route it from your alternator over to the area where you have mounted your Megafuse and cut it to length. Strip the insulation on each end back 1/2". Install 1 piece of shrink tubing F onto the wire. At the alternator end, slip on boot E as shown on page 3, then crimp and solder (1) of terminal J onto the wire. At the Megafuse end, crimp and solder (1) of terminal H onto the wire. Slide the shrink tubing over terminal H and heat it up to shrink it down.
4. Take the 10Ga. red main power feed wire from your engine or panel sub-kit and route it over to the area where you have mounted your Megafuse and cut it to length. Strip the insulation back 3/8". Install 1 piece of shrink tubing F onto the wire, then crimp and solder (1) of terminal K onto the wire.
5. Remove the 4 loosely tightened nuts and lock washers from the assembled Megafuses, then using the drawing on page 3 as a guide, install your pre-assembled wires from steps 2-4 above. Re-install the 4 nuts and lock washers onto the assembled Megafuses and tighten them down. This part of your installation is now complete.

510476

Z

DESCRIPTION:

**Alternator and Main Power
Connection Kit
Various Applications**

92972153 instruction sheet rev 0.1 6/24/2019

Most switches supplied with Classic Update and Universal Kits ship with the shaft pre-installed. In many instances, the switch can be installed without removing the shaft, but in some cases the switch shaft may need to be trimmed to fit your specific dash. In this situation, reference Trim to Fit instructions on the back of this page for details.

To install your new headlight switch:

1. Install the switch from behind the dash, and align the switch body with the mounting hole. The switch body has an alignment tab that must line up with the notch in the dashboard mounting hole.

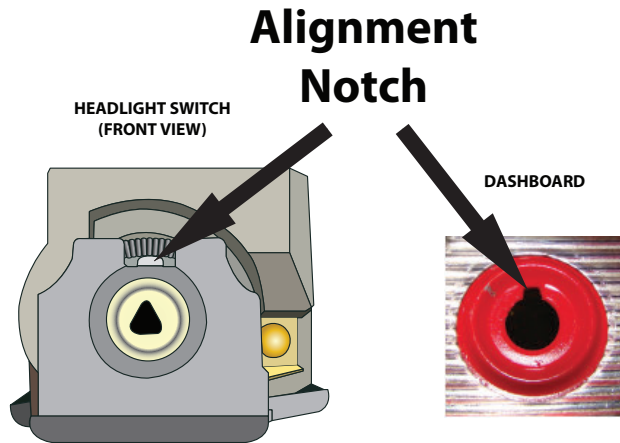

2. Install the switch mounting nut and tighten.

3. Gently press shaft into switch until it stops, then press firmly until it “clicks.” Pull shaft back out to confirm it is seated correctly. The shaft should be locked into place inside switch.

4. If the shaft does not lock, reinsert applying moderate pressure and slowly move shaft side to side for lock to engage. Make sure switch body is still supported to prevent flexing. Press shaft firmly until it clicks into place.

5. Ensure the shaft is fully seated and in the off position.

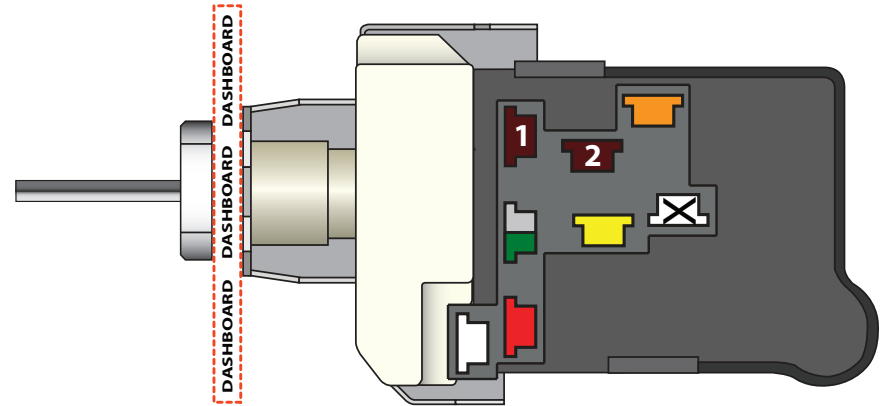

1	Parking Lights - Stay on with headlights
2	Tail Lights - On in the park and headlight positions
	Fused Battery Feed - For park, tail and dash lamps
	Headlight Feed - Power to the headlight dimmer switch
	12V Battery Feed - Unfused power to the switch for headlights
	Courtesy Ground - Ground feed to the dome and courtesy lights
	Part-time Parking Lights - Turns off when the headlights are on (Not supported by all kits)
	Dash Lights - Output to the dash light fuse or lights



www.americanautowire.com 856-933-0801

PART #

500332

DESCRIPTION:

Headlight Switch

92964649 Rev 3.0 1/10/2020

To Trim Shaft to Fit or Remove Shaft:

The headlight shaft knob should extend from the face of the mounting nut, and must allow enough clearance for the switch to turn off. If the shaft is longer than necessary for your specific dash it can be trimmed to fit. Always trim the knob end of the shaft only and follow the guidelines below for best results.

1. With the headlight switch installed, loosen the set screw and remove the knob. Make sure the switch is in the "off" position by pushing the shaft toward the back of the switch.

Switch in OFF position
(shaft pushed all the way in)

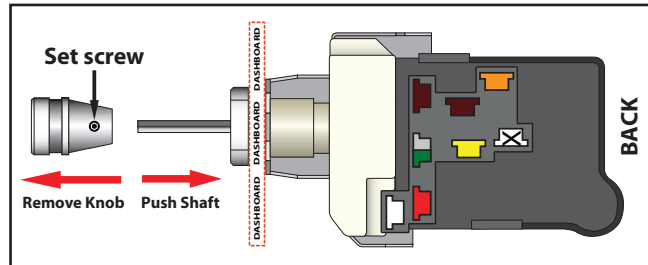

2. Set knob alongside shaft and mark the desired location for cutting on the shaft.

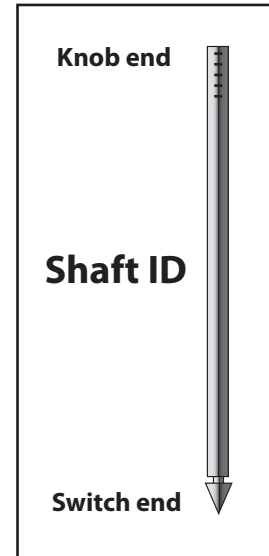
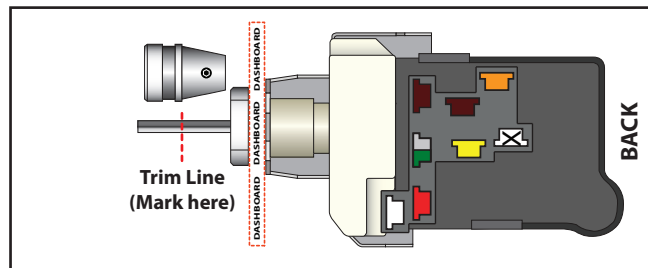

3. Remove the shaft and trim at mark. The shaft can be released from the switch by pulling it outward (toward the rear of the vehicle). Once fully in the "On" position, press and hold the release button on the base of the switch body. Once button is pressed, continue to pull the shaft outward. New switches may be tight, and it might be necessary to move the shaft side to side slightly while pulling to release.

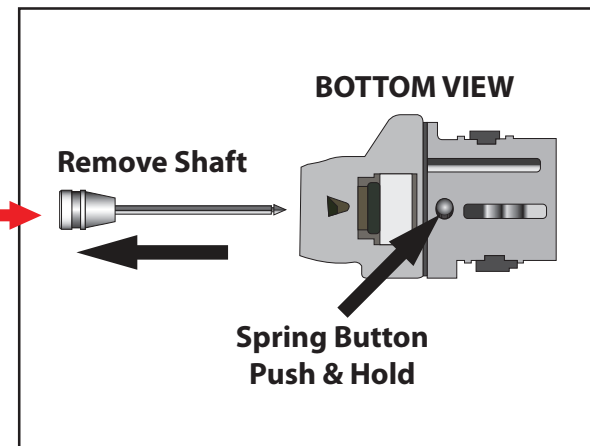
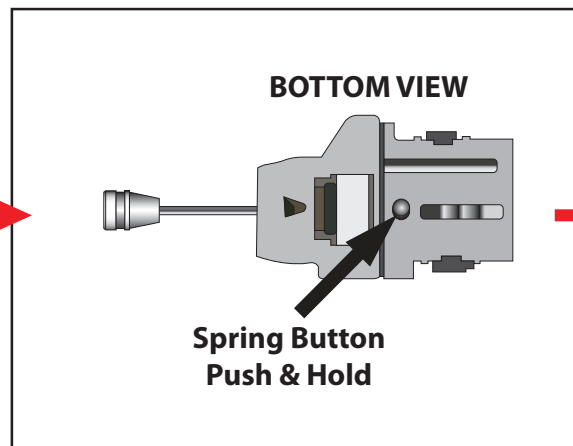
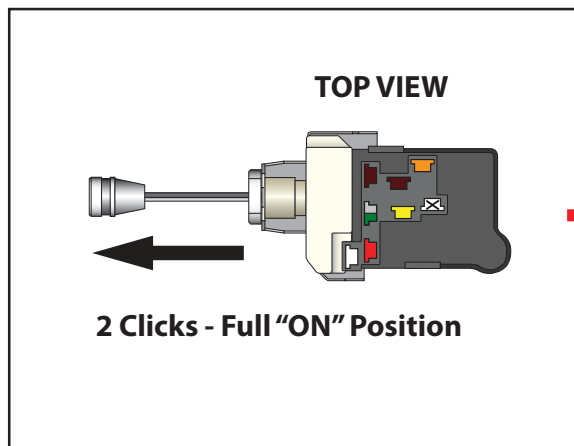

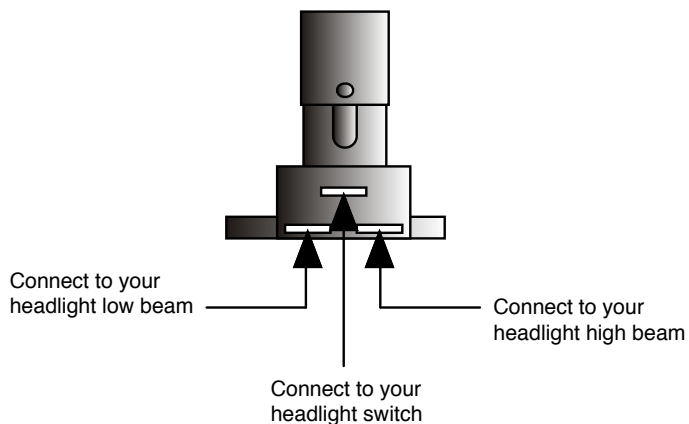

Connect the Dimmer Switch wires as shown above.

1. The top center terminal of the Dimmer Switch is connected to the Headlight switch.
2. The terminal on the right side is connected to your headlight high beam terminal.
3. The terminal on the left side is connected to your headlight low beam terminal.



www.americanautowire.com 856-933-0801

PART #

500042

DESCRIPTION:

DIMMER SWITCH

92964573 Rev 3.1 12/5/2014

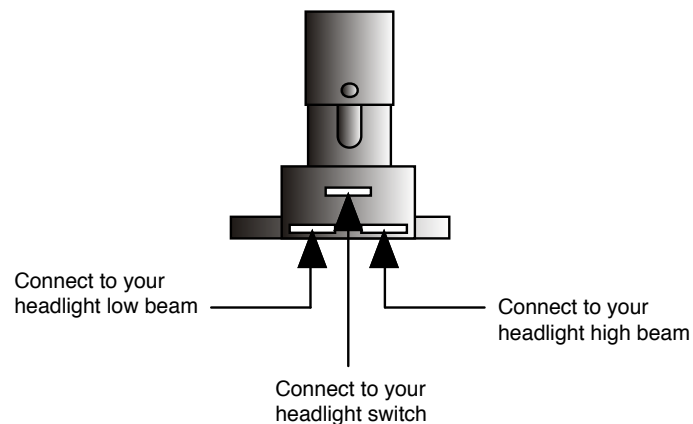

Connect the Dimmer Switch wires as shown above.

1. The top center terminal of the Dimmer Switch is connected to the Headlight switch.
2. The terminal on the right side is connected to your headlight high beam terminal.
3. The terminal on the left side is connected to your headlight low beam terminal.



www.americanautowire.com 856-933-0801

PART #

500042

DESCRIPTION:

DIMMER SWITCH

92964573 Rev 3.1 12/5/2014